

**Z170M-PLUS**

**ASUS**<sup>®</sup>

**Motherboard**

E10768

First Edition  
August 2015

**Copyright © 2015 ASUSTeK COMPUTER INC. All Rights Reserved.**

No part of this manual, including the products and software described in it, may be reproduced, transmitted, transcribed, stored in a retrieval system, or translated into any language in any form or by any means, except documentation kept by the purchaser for backup purposes, without the express written permission of ASUSTeK COMPUTER INC. ("ASUS").

Product warranty or service will not be extended if: (1) the product is repaired, modified or altered, unless such repair, modification or alteration is authorized in writing by ASUS; or (2) the serial number of the product is defaced or missing.

ASUS PROVIDES THIS MANUAL "AS IS" WITHOUT WARRANTY OF ANY KIND, EITHER EXPRESS OR IMPLIED, INCLUDING BUT NOT LIMITED TO THE IMPLIED WARRANTIES OR CONDITIONS OF MERCHANTABILITY OR FITNESS FOR A PARTICULAR PURPOSE. IN NO EVENT SHALL ASUS, ITS DIRECTORS, OFFICERS, EMPLOYEES OR AGENTS BE LIABLE FOR ANY INDIRECT, SPECIAL, INCIDENTAL, OR CONSEQUENTIAL DAMAGES (INCLUDING DAMAGES FOR LOSS OF PROFITS, LOSS OF BUSINESS, LOSS OF USE OR DATA, INTERRUPTION OF BUSINESS AND THE LIKE), EVEN IF ASUS HAS BEEN ADVISED OF THE POSSIBILITY OF SUCH DAMAGES ARISING FROM ANY DEFECT OR ERROR IN THIS MANUAL OR PRODUCT.

SPECIFICATIONS AND INFORMATION CONTAINED IN THIS MANUAL ARE FURNISHED FOR INFORMATIONAL USE ONLY, AND ARE SUBJECT TO CHANGE AT ANY TIME WITHOUT NOTICE, AND SHOULD NOT BE CONSTRUED AS A COMMITMENT BY ASUS. ASUS ASSUMES NO RESPONSIBILITY OR LIABILITY FOR ANY ERRORS OR INACCURACIES THAT MAY APPEAR IN THIS MANUAL, INCLUDING THE PRODUCTS AND SOFTWARE DESCRIBED IN IT.

Products and corporate names appearing in this manual may or may not be registered trademarks or copyrights of their respective companies, and are used only for identification or explanation and to the owners' benefit, without intent to infringe.

**Offer to Provide Source Code of Certain Software**

This product contains copyrighted software that is licensed under the General Public License ("GPL"), under the Lesser General Public License Version ("LGPL") and/or other Free Open Source Software Licenses. Such software in this product is distributed without any warranty to the extent permitted by the applicable law. Copies of these licenses are included in this product.

Where the applicable license entitles you to the source code of such software and/or other additional data, you may obtain it for a period of three years after our last shipment of the product, either

(1) for free by downloading it from <http://support.asus.com/download>  
or

(2) for the cost of reproduction and shipment, which is dependent on the preferred carrier and the location where you want to have it shipped to, by sending a request to:

ASUSTeK Computer Inc.  
Legal Compliance Dept.  
15 Li Te Rd.,  
Beitou, Taipei 112  
Taiwan

In your request please provide the name, model number and version, as stated in the About Box of the product for which you wish to obtain the corresponding source code and your contact details so that we can coordinate the terms and cost of shipment with you.

The source code will be distributed WITHOUT ANY WARRANTY and licensed under the same license as the corresponding binary/object code.

This offer is valid to anyone in receipt of this information.

ASUSTeK is eager to duly provide complete source code as required under various Free Open Source Software licenses. If however you encounter any problems in obtaining the full corresponding source code we would be much obliged if you give us a notification to the email address [gpl@asus.com](mailto:gpl@asus.com), stating the product and describing the problem (please DO NOT send large attachments such as source code archives, etc. to this email address).

# Contents

Safety information .....	iv
About this guide .....	iv
Package contents .....	vi
Z170M-PLUS specifications summary .....	vi

## Chapter 1: Product introduction

1.1 Before you proceed .....	1-1
1.2 Motherboard overview .....	1-1
1.3 Central Processing Unit (CPU) .....	1-4
1.4 System memory .....	1-7
1.5 Expansion slots.....	1-10
1.6 Headers .....	1-12
1.7 Connectors .....	1-13
1.8 Onboard LED .....	1-23
1.9 Software support.....	1-24

## Chapter 2: BIOS information

2.1 Managing and updating your BIOS .....	2-1
2.2 BIOS setup program .....	2-6
2.3 My Favorites .....	2-16
2.4 Main menu .....	2-18
2.5 Ai Tweaker menu.....	2-20
2.6 Advanced menu .....	2-30
2.7 Monitor menu .....	2-39
2.8 Boot menu .....	2-43
2.9 Tool menu .....	2-48
2.10 Exit menu .....	2-49

## Appendices

Notices.....	A-1
ASUS contact information .....	A-4

# Safety information

## Electrical safety

- To prevent electrical shock hazard, disconnect the power cable from the electrical outlet before relocating the system.
- When adding or removing devices to or from the system, ensure that the power cables for the devices are unplugged before the signal cables are connected. If possible, disconnect all power cables from the existing system before you add a device.
- Before connecting or removing signal cables from the motherboard, ensure that all power cables are unplugged.
- Seek professional assistance before using an adapter or extension cord. These devices could interrupt the grounding circuit.
- Ensure that your power supply is set to the correct voltage in your area. If you are not sure about the voltage of the electrical outlet you are using, contact your local power company.
- If the power supply is broken, do not try to fix it by yourself. Contact a qualified service technician or your retailer.

## Operation safety

- Before installing the motherboard and adding components, carefully read all the manuals that came with the package.
- Before using the product, ensure all cables are correctly connected and the power cables are not damaged. If you detect any damage, contact your dealer immediately.
- To avoid short circuits, keep paper clips, screws, and staples away from connectors, slots, sockets and circuitry.
- Avoid dust, humidity, and temperature extremes. Do not place the product in any area where it may be exposed to moisture.
- Place the product on a stable surface.
- If you encounter technical problems with the product, contact a qualified service technician or your retailer.

## About this guide

This user guide contains the information you need when installing and configuring the motherboard.

## How this guide is organized

This guide contains the following parts:

- **Chapter 1: Product introduction**  
This chapter describes the features of the motherboard and the new technology it supports. It includes descriptions of the switches, jumpers, and connectors on the motherboard.
- **Chapter 2: BIOS information**  
This chapter discusses changing system settings through the BIOS Setup menus. Detailed descriptions for the BIOS parameters are also provided.

## Where to find more information

Refer to the following sources for additional information and for product and software updates.

### 1. ASUS websites

The ASUS website provides updated information on ASUS hardware and software products. Refer to the ASUS contact information.

### 2. Optional documentation

Your product package may include optional documentation, such as warranty flyers, that may have been added by your dealer. These documents are not part of the standard package.

## Conventions used in this guide

To ensure that you perform certain tasks properly, take note of the following symbols used throughout this manual.



**DANGER/WARNING:** Information to prevent injury to yourself when completing a task.



**CAUTION:** Information to prevent damage to the components when completing a task.



**IMPORTANT:** Instructions that you **MUST** follow to complete a task.



**NOTE:** Tips and additional information to help you complete a task.

## Typography

**Bold text**

Indicates a menu or an item to select.

*Italics*

Used to emphasize a word or a phrase.

<Key>

Keys enclosed in the less-than and greater-than sign means that you must press the enclosed key.

Example: <Enter> means that you must press the Enter or Return key.

<Key1> + <Key2> + <Key3>

If you must press two or more keys simultaneously, the key names are linked with a plus sign (+).

## Package contents

Check your motherboard package for the following items.

<b>Motherboard</b>	ASUS Z170M-PLUS motherboard
<b>Cables</b>	2 x Serial ATA 6.0 Gb/s cables
<b>Accessories</b>	1 x I/O Shield 1 x M.2 screw package
<b>Application DVD</b>	Support DVD
<b>Documentation</b>	User Guide



If any of the above items is damaged or missing, contact your retailer.

## Z170M-PLUS specifications summary

<b>CPU</b>	LGA1151 socket for Intel® 6th Generation Core™ i7 / i5 / i3, Pentium®, and Celeron® processors Supports Intel® 14nm CPU Supports Intel® Turbo Boost Technology 2.0* * <b>The Intel® Turbo Boost Technology 2.0 support depends on the CPU types.</b> ** <b>Refer to <a href="http://www.asus.com">www.asus.com</a> for Intel® CPU support list.</b>
<b>Chipset</b>	Intel® Z170 Express Chipset
<b>Memory</b>	4 x DIMM, maximum 64 GB, DDR4 3466(O.C.)/3400(O.C.)/3333(O.C.)/3300(O.C.)/3200(O.C.)/3000(O.C.)/2800(O.C.)*/2666(O.C.)*/2400(O.C.)*/2133 MHz, non-ECC, un-buffered memory Dual-channel memory architecture Supports Intel® Extreme Memory Profile (XMP) * <b>Hyper DIMM support is subject to the physical characteristics of individual CPUs. Please refer to Memory QVL (Qualified Vendors List) for details.</b>
<b>Graphics</b>	Integrated graphics processor - Intel® HD Graphics support Multi-VGA output support: HDMI, DVI-D, RGB ports - Supports HDMI with maximum resolution of 4096 x 2160 @24Hz / 2560 x 1600 @60Hz - Supports DVI-D with maximum resolution of 1920 x 1200 @60Hz - Supports RGB with maximum resolution of 1920 x 1200 @60Hz Supports up to three displays simultaneously Supports Intel® InTru™ 3D, Quick Sync Video, Intel® Clear Video HD Technology, and Intel® Insider™ Maximum shared memory of 1024 MB
<b>Expansion Slots</b>	1 x PCI Express 3.0/2.0 x16 slot (at x16 mode) 1 x PCI Express 3.0/2.0 x16 slot (max. at x4 mode) 2 x PCI Express 3.0/2.0 x1 slots

(continued on the next page)

# Z170M-PLUS specifications summary

<b>Multi-GPU Support</b>	Supports AMD® Quad-GPU CrossFireX™ Technology
<b>Audio</b>	Realtek® ALC887 7.1-channel High Definition Audio CODEC  <b>Audio Features</b> <ul style="list-style-type: none"> <li>- Audio Shielding: Ensures precision analog/digital separation and greatly reduced multi-lateral interference</li> <li>- Dedicated audio PCB layers: Separate layers for left and right channels to guard the quality of the sensitive audio signals</li> <li>- Premium Japanese-made audio capacitors: Provide warm, natural and immersive sound with exceptional clarity and fidelity.</li> <li>- Supports jack-detection and front panel jack-retasking.</li> </ul>
<b>Storage</b>	Intel® Z170 Express Chipset with RAID 0, 1, 5, 10 and Intel Rapid Storage Technology 14 support <ul style="list-style-type: none"> <li>- 1 x SATA Express port (compatible with 2 x SATA 6.0 Gb/s ports)</li> <li>- 1 x M.2 Socket 3 with M Key, type 2242/2260/2280 storage devices support (both SATA &amp; PCIE mode)*</li> <li>- 6 x SATA 6.0 Gb/s ports (gray, 2 from SATA Express)</li> <li>- Supports Intel® Smart Response Technology**</li> </ul> <p>* M.2 socket and SATA Express connector support PCIe and SATA devices in PCIe and SATA modes.                  When a device in PCIe mode is installed on the M.2 socket, SATA Express supports devices in both PCIe and SATA modes.                  When a device in SATA mode is installed on the M.2 socket, SATA Express supports one PCIe mode device or one SATA mode device (installed on SATA6G 2 connector only). In this setup, the system sets a higher priority for M.2 socket than the SATA Express connector.</p> <p>** These functions work depending on the type of CPU installed.</p>
<b>LAN</b>	Intel I219-V Gigabit LAN Dual interconnect between the integrated Media Access Controller (MAC) and physical layer (PHY)
<b>USB</b>	Intel® Z170 Express Chipset - supports ASUS USB 3.0 Boost <ul style="list-style-type: none"> <li>- 6 x USB 3.0 / 2.0 ports (4 ports at mid-board, 2 ports at the rear panel, blue, Type A)</li> <li>- 1 x USB 5Gb/s Type C port supports 3A power output</li> <li>- 6 x USB 2.0/1.1 ports (4 ports at mid-board, 2 ports at the rear panel)</li> </ul>
<b>ASUS Unique Features</b>	<b>ASUS 5X PROTECTION II</b> <ul style="list-style-type: none"> <li>- ASUS DIGI+ VRM - 4+2+1 phase digital power design</li> <li>- ASUS Enhanced DRAM Overcurrent Protection - Short circuit damage prevention</li> <li>- ASUS LAN Guard</li> <li>- ASUS Overvoltage Protection</li> <li>- ASUS Stainless Steel Back I/O - 3x more durable corrosion-resistant coating</li> </ul> <b>Superb Performance</b> <b>M.2 onboard</b> <ul style="list-style-type: none"> <li>- The latest transfer technologies with up to 32Gb/s data transfer speeds</li> </ul> <b>ASUS Fan Xpert 3</b> <ul style="list-style-type: none"> <li>- Featuring Fan Auto Tuning function and multiple thermistors selection for optimized system cooling control</li> </ul>

(continued on the next page)

# Z170M-PLUS specifications summary

ASUS Unique Features	<b>ASUS EPU</b> <ul style="list-style-type: none"><li>- EPU</li></ul>
	<b>PC Cleaner</b> <ul style="list-style-type: none"><li>- Fast and easy way to get rid of unnecessary junk files</li></ul>
	<b>USB 3.0 Boost</b> <ul style="list-style-type: none"><li>- Featuring speedy USB 3.0 transmission</li></ul>
	<b>Gaming Scenario</b>
	<b>eSports Champions</b> <ul style="list-style-type: none"><li>- Audio Features - Audio that roars on the battlefield</li></ul>
	<b>Media Streamer</b> <ul style="list-style-type: none"><li>- Pipe music or movies from your PC to a smart TV, your entertainment goes wherever you go!</li><li>- Media Streamer app for portable smart phone/tablet, supporting iOS 7 &amp; Android 4.0 systems</li></ul>
	<b>ASUS Exclusive Features</b> <ul style="list-style-type: none"><li>- ASUS Ai Charger</li><li>- ASUSAI Suite 3</li><li>- ASUS Disk Unlocker featuring 3TB + HDD support</li><li>- ASUS Anti Surge</li></ul>
	<b>EZ DIY</b>
	<b>Push Notice</b> <ul style="list-style-type: none"><li>- Monitor your PC status with smart devices in real time</li></ul>
	<b>UEFI BIOS EZ Mode</b> <ul style="list-style-type: none"><li>- Featuring friendly graphics user interface</li><li>- ASUS O.C. Tuner</li><li>- ASUS CrashFree BIOS 3</li><li>- ASUS EZ Flash 3</li></ul>
	<b>Q-Design</b> <ul style="list-style-type: none"><li>- ASUS Q-Slot</li><li>- ASUS Q-DIMM</li></ul>
	ASUS Exclusive Overclocking Features

(continued on the next page)



# Z170M-PLUS specifications summary

<b>ASUS Exclusive Overclocking Features</b>	<b>SFS (Stepless Frequency Selection)</b> - BCLK/PCIE frequency tuning from 40MHz up to 170MHz at 0.1MHz increment  <b>Overclocking Protection</b> - ASUS CPR (CPU Parameter Recall)
<b>ASUS Quiet Thermal Solution</b>	<b>Quiet Thermal Design</b> - ASUS Fan Xpert 3 - ASUS Fanless Design: PCH Heatsink & MOS Heatsink solution
<b>Rear Panel I/O Ports</b>	1 x PS/2 keyboard port (purple) 1 x PS/2 mouse port (green) 1 x HDMI port 1 x DVI-D port 1 x RGB port 1 x LAN (RJ-45) port 1 x USB 5Gb/s Type C port 2 x USB 3.0/2.0 ports (Type A, blue) 2 x USB 2.0/1.1 ports 3 x Audio jacks support 7.1-channel audio output* * <b>Use a chassis with HD audio module in the front panel to support a 8-channel audio output.</b>
<b>Internal I/O Connectors</b>	2 x USB 3.0 / 2.0 connector support additional 4 USB 3.0 / 2.0 ports (19-pin) 2 x USB 2.0 / 1.1 connectors support additional 4 USB 2.0 / 1.1 ports 1 x M.2 Socket 3 (for M Key, type 2242/2260/2280 devices) 1 x SATA Express connector (compatible with 2 x SATA 6.0 Gb/s ports) 6 x SATA 6.0 Gb/s connectors (gray; 2 from SATA Express) 1 x 4-pin CPU fan connector for both 3-pin (DC mode) and 4-pin (PWM mode) CPU coolers control* 2 x 4-pin Chassis fan connectors (4-pin) for both 3-pin (DC mode) and 4-pin (PWM mode) coolers control 1 x Front panel audio connector (AAFP) 1 x S/PDIF out header 1 x COM connector 1 x LPT connector 1 x 24-pin EATX power connector 1 x 8-pin EATX 12V power connector 1 x System panel connector 1 x Clear CMOS jumper * <b>By default, the CPU Q-Fan control setting is set to Auto mode, which detects the CPU fan installed and changes the control mode automatically.</b>

(continued on the next page)

## Z170M-PLUS specifications summary

<b>BIOS features</b>	128 Mb Flash ROM, UEFI AMI BIOS, PnP, DMI 3.0, WfM2.0, SM BIOS 3.0, ACPI 5.0, Multi-language BIOS, ASUS EZ Flash 3, ASUS CrashFree BIOS 3, F11 EZ Tuning Wizard, F6 Qfan Control, F3 My Favorites, Quick Note, Last Modified Log, F12 PrintScreen function, and ASUS DRAM SPD (Serial Presence Detect) memory information
<b>Manageability</b>	WfM 2.0, DMI 3.0, WOL by PME, PXE
<b>Support DVD</b>	Drivers ASUS utilities EZ Update Anti-virus software (OEM version)
<b>OS support</b>	Windows® 10 (64-bit) Windows® 8.1 (64-bit) Windows® 7 (32-bit/64-bit)*  * Please refer to <b>ASUS official website</b> and download “Windows® 7 Installation Guide” and “EZ Installer” to install Windows® 7.
<b>Form factor</b>	Micro-ATX form factor: 9.6 in. x 8.95 in. (24.4 cm x 22.7 cm)



---

Specifications are subject to change without notice.

---

# Product introduction

# 1

## 1.1 Before you proceed

Take note of the following precautions before you install motherboard components or change any motherboard settings.



- 
- Unplug the power cord from the wall socket before touching any component.
  - Before handling components, use a grounded wrist strap or touch a safely grounded object or a metal object, such as the power supply case, to avoid damaging them due to static electricity.
  - Before you install or remove any component, ensure that the ATX power supply is switched off or the power cord is detached from the power supply. Failure to do so may cause severe damage to the motherboard, peripherals, or components.
- 

## 1.2 Motherboard overview

Before you install the motherboard, study the configuration of your chassis to ensure that the motherboard fits.



---

Unplug the power cord before installing or removing the motherboard. Failure to do so can cause you physical injury and damage to motherboard components.

---

### 1.2.1 Placement direction

When installing the motherboard, place it into the chassis in the correct orientation. The edge with external ports goes to the rear part of the chassis as indicated in the image.

### 1.2.2 Screw holes

Place six screws into the holes indicated by circles to secure the motherboard to the chassis.



---

Do not overtighten the screws! Doing so can damage the motherboard.

---



## 1.2.4 Layout contents

Connectors/Jumpers/Slots/LED	Page
1. ATX power connectors (24-pin EATXPWR, 8-pin ATX12V)	1-17
2. CPU, chassis fan connectors (4-pin CPU_FAN, 4-pin CHA_FAN1~2)	1-20
3. Intel® LGA1151 CPU socket	1-4
4. M.2 Socket 3	1-19
5. DDR4 DIMM slots	1-7
6. Standby power LED (SB_PWR)	1-23
7. USB 3.0 connectors (20-1 pin USB3_12, USB3_34)	1-16
8. Intel® Z170 Serial ATA 6.0Gb/s connectors (7-pin SATA 6G_1~6, SATA EXPRESS)	1-21
9. System panel connector (20-5 pin PANEL)	1-22
10. Clear RTC RAM (2-pin CLRTC)	1-12
11. USB 2.0 connectors (10-1 pin USB1112, USB1314)	1-15
12. Serial port connectors (10-1 pin COM)	1-15
13. LPT connector (26-1 pin LPT)	1-18
14. Front panel audio connector (10-1 pin AAFP)	1-18
15. Digital audio connector (4-1 pin SPDIF_OUT)	1-20

### 1.3 Central Processing Unit (CPU)

This motherboard comes with a surface mount LGA1151 socket designed for the 6th Generation Intel® Core™ i7 / Core™ i5 / Core™ i3, Pentium® and Celeron® processors.

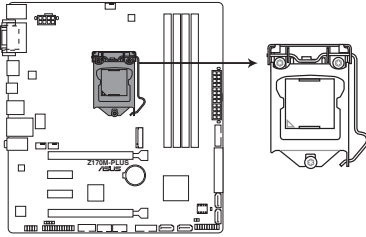

**Z170M-PLUS CPU socket LGA1151**



---

Unplug all power cables before installing the CPU.

---



- Ensure that you install the correct CPU designed for the LGA1151 socket only. DO NOT install a CPU designed for LGA1150, LGA1155 and LGA1156 sockets on the LGA1151 socket.
  - Upon purchase of the motherboard, ensure that the PnP cap is on the socket and the socket contacts are not bent. Contact your retailer immediately if the PnP cap is missing, or if you see any damage to the PnP cap/socket contacts/motherboard components.
  - Keep the cap after installing the motherboard. ASUS will process Return Merchandise Authorization (RMA) requests only if the motherboard comes with the cap on the LGA1151 socket.
  - The product warranty does not cover damage to the socket contacts resulting from incorrect CPU installation/removal, or misplacement/loss/incorrect removal of the PnP cap.
-

### 1.3.1 Installing the CPU

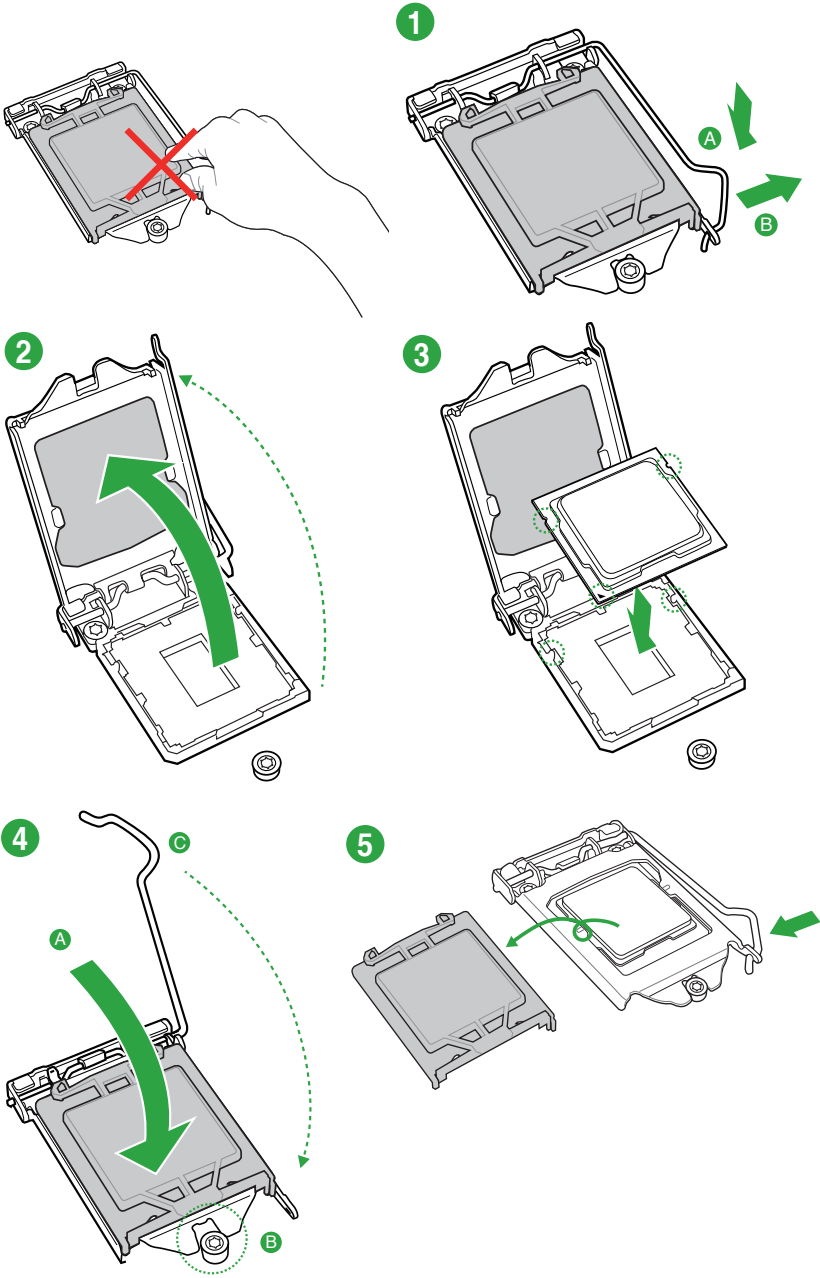

### 1.3.2 CPU heatsink and fan assembly installation

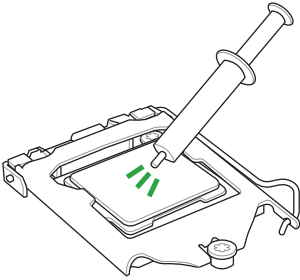

Apply the Thermal Interface Material to the CPU heatsink and CPU before you install the heatsink and fan if necessary.

To install the CPU heatsink and fan assembly

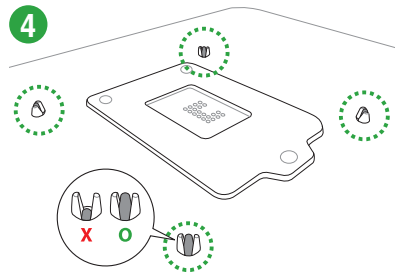
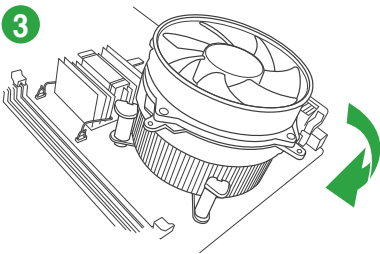
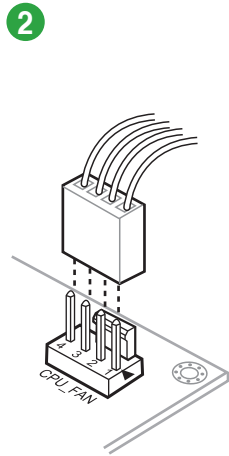
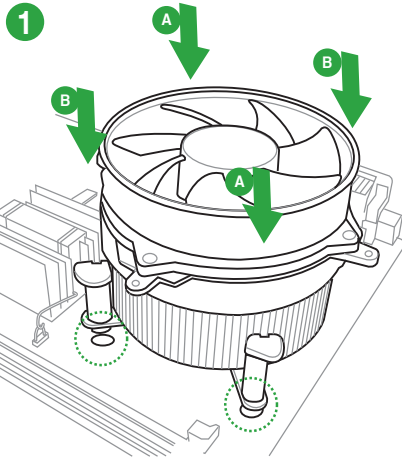



## To uninstall the CPU heatsink and fan assembly

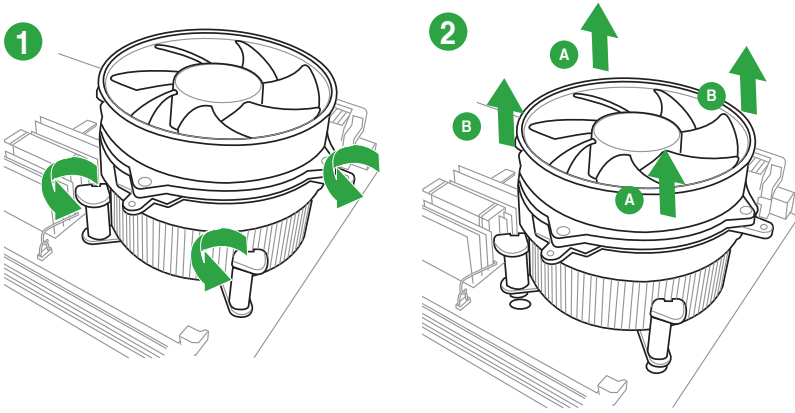

## 1.4 System memory

### 1.4.1 Overview

This motherboard comes with four Double Data Rate 4 (DDR4) Dual Inline Memory Module (DIMM) sockets. A DDR4 module is notched differently from a DDR, DDR2 or DDR3 module. DO NOT install a DDR, DDR2, or DDR3 memory module to the DDR4 slot. The figure illustrates the location of the DDR4 DIMM sockets:



According to Intel® CPU spec, DIMM voltage below 1.35 V is recommended to protect the CPU.

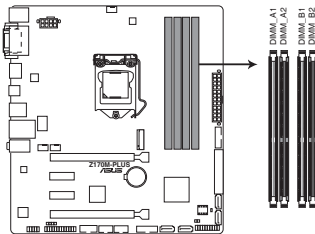

**Z170M-PLUS 288-pin DDR4 DIMM sockets**

## 1.4.2 Memory configurations

You may install 2 GB, 4 GB, 8 GB and 16 GB unbuffered non-ECC DDR4 DIMMs into the DIMM sockets.

### Recommended memory configurations

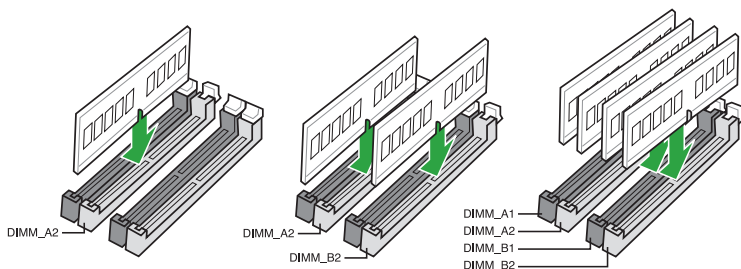

- You may install varying memory sizes in Channel A and Channel B. The system maps the total size of the lower-sized channel for the dual-channel configuration. Any excess memory from the higher-sized channel is then mapped for single-channel operation.
- Due to the memory address limitation on 32-bit Windows® OS, when you install 4GB or more memory on the motherboard, the actual usable memory for the OS can be about 3GB or less. For effective use of memory, we recommend that you do any of the following:
  - Use a maximum of 3 GB system memory if you are using a 32-bit Windows® OS.
  - Install a 64-bit Windows® OS if you want to install 4GB or more on the motherboard.
  - For more details, refer to the Microsoft® support site at <http://support.microsoft.com/kb/929605/en-us>.



- The default memory operation frequency is dependent on its Serial Presence Detect (SPD), which is the standard way of accessing information from a memory module. Under the default state, some memory modules for overclocking may operate at a lower frequency than the vendor-marked value. To operate at the vendor-marked or at a higher frequency, refer to section **2.5 Ai Tweaker menu** for manual memory frequency adjustment.
- Always install the DIMMs with the same CAS Latency. For an optimum compatibility, we recommend that you install memory modules of the same version or data code (D/C) from the same vendor. Check with the vendor to get the correct memory modules.
- Visit the ASUS website at [www.asus.com](http://www.asus.com) for the latest QVL.

### 1.4.3 Installing a DIMM

1

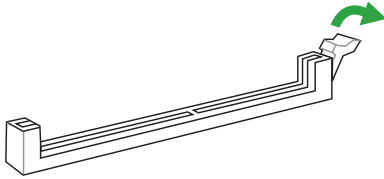

2

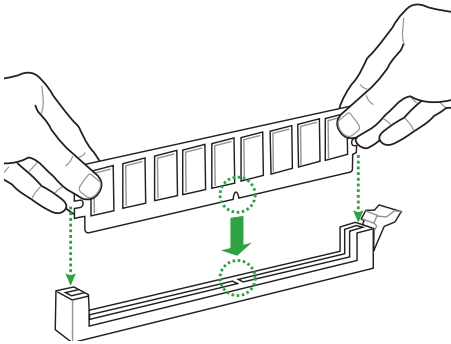

3

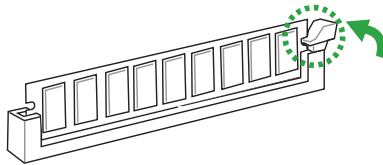

To remove a DIMM

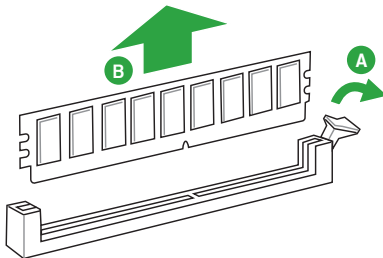

## 1.5 Expansion slots

In the future, you may need to install expansion cards. The following sub-sections describe the slots and the expansion cards that they support.



---

Unplug the power cord before adding or removing expansion cards. Failure to do so may cause you physical injury and damage motherboard components.

---

### 1.5.1 Installing an expansion card

**To install an expansion card:**

1. Before installing the expansion card, read the documentation that came with it and make the necessary hardware settings for the card.
2. Remove the system unit cover (if your motherboard is already installed in a chassis).
3. Remove the bracket opposite the slot that you intend to use. Keep the screw for later use.
4. Align the card connector with the slot and press firmly until the card is completely seated on the slot.
5. Secure the card to the chassis with the screw you removed earlier.
6. Replace the system cover.

### 1.5.2 Configuring an expansion card

After installing the expansion card, configure it by adjusting the software settings.

1. Turn on the system and change the necessary BIOS settings, if any. See Chapter 2 for information on BIOS setup.
2. Assign an IRQ to the card.
3. Install the software drivers for the expansion card.



---

When using PCI cards on shared slots, ensure that the drivers support "Share IRQ" or that the cards do not need IRQ assignments. Otherwise, conflicts will arise between the two PCI groups, making the system unstable and the card inoperable.

---

### 1.5.3 PCI Express 3.0 x1 slots

This motherboard supports PCI Express 3.0 x1 network cards, SCSI cards, and other cards that comply with the PCI Express specifications.

### 1.5.4 PCI Express 3.0 x16 slots

This motherboard has two PCI Express 3.0 x16 slots that support PCI Express 3.0 x16 graphic cards complying with the PCI Express specifications.

VGA configuration	PCI Express operating mode	
	PCIe 3.0 x16_1 (gray)	PCIe 3.0 x16_2
Single VGA/PCIe card	x16 (Recommended for single VGA card)	N/A
Dual VGA/PCIe cards	x16	x4



- In single VGA card mode, use the PCIe 3.0 x16\_1 slot (gray) for a PCI Express x16 graphics card to get better performance.
- We recommend that you provide sufficient power when running CrossFireX™ mode.
- Connect a chassis fan to the motherboard connector labeled CHA\_FAN1/2 when using multiple graphics cards for better thermal environment.

### IRQ assignments for this motherboard

	A	B	C	D
PCIEx16_1	shared	-	-	-
PCIEx16_2	shared	-	-	-
PCIEx1_1	-	-	shared	-
PCIEx1_2	-	-	-	shared
Intel GBE LAN	shared	-	-	-
USB 3.0 Controller	shared	-	-	-
M.2 Socket	shared	-	-	-
SATA Express	shared	-	-	-
SATA Controller	shared	-	-	-
HD Audio	shared	-	-	-

## 1.6 Headers

### 1. Clear RTC RAM (2-pin CLRRTC)

This header allows you to clear the Real Time Clock (RTC) RAM in CMOS. You can clear the CMOS memory of date, time, and system setup parameters by erasing the CMOS RTC RAM data. The onboard button cell battery powers the RAM data in CMOS, which include system setup information such as system passwords.

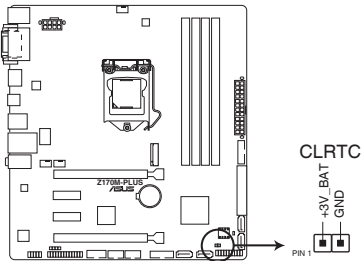

**Z170M-PLUS Clear RTC RAM**

#### To erase the RTC RAM:

1. Turn OFF the computer and unplug the power cord.
2. Use a metal object such as a screwdriver to short the two pins.
3. Plug the power cord and turn on the computer.
4. Hold down the <Del> key during the boot process and enter BIOS setup to re-enter data.



- 
- If the steps above do not help, remove the onboard battery and short the two pins again to clear the CMOS RTC RAM data. After clearing the CMOS, reinstall the battery.
  - You do not need to clear the RTC when the system hangs due to overclocking. For system failure due to overclocking, use the CPU Parameter Recall (C.P.R.) feature. Shut down and reboot the system, then the BIOS automatically resets parameter settings to default values.
-

## 1.7 Connectors

### 1.7.1 Rear panel connectors

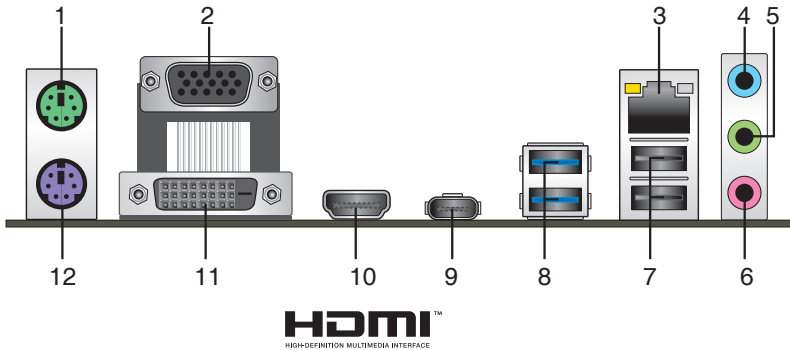

1. **PS/2 mouse port (green).** This port is for a PS/2 mouse.
2. **Video Graphics Adapter (VGA) port.** This 15-pin port is for a VGA monitor or other VGA-compatible devices.
3. **LAN (RJ-45) port.** This port allows Gigabit connection to a Local Area Network (LAN) through a network hub.

#### LAN port LED indications

Activity/Link LED		Speed LED	
Status	Description	Status	Description
Off	No link	OFF	10Mbps connection
Orange	Linked	ORANGE	100Mbps connection
Orange (Blinking)	Data activity	GREEN	1Gbps connection
Orange (Blinking then steady)	Ready to wake up from S5 mode	—	—

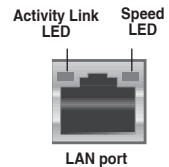

4. **Line In port (light blue).** This port connects to the tape, CD, DVD player, or other audio sources.
5. **Line Out port (lime).** This port connects to a headphone or a speaker. In the 4.1, 5.1 and 7.1-channel configurations, the function of this port becomes Front Speaker Out.
6. **Microphone port (pink).** This port connects to a microphone.



Refer to the audio configuration table for the function of the audio ports in 2.1, 4.1, 5.1, or 7.1-channel configuration.

## Audio 2.1, 4.1, 5.1, or 7.1-channel configuration

Port	Headset 2.1-channel	4.1-channel	5.1-channel	7.1-channel
Light Blue (Rear panel)	Line In	Rear Speaker Out	Rear Speaker Out	Rear Speaker Out
Lime (Rear panel)	Line Out	Front Speaker Out	Front Speaker Out	Front Speaker Out
Pink (Rear panel)	Mic In	Mic In	Bass/Center	Bass/Center
Lime (Front panel)	-	-	-	Side Speaker Out



### To configure an 7.1-channel audio output:

Use a chassis with HD audio module in the front panel to support an 7.1-channel audio output.

- 7. USB 2.0 ports.** These 4-pin Universal Serial Bus (USB) ports are for USB 2.0/1.1 devices.
- 8. USB 3.0 ports.** These 9-pin Universal Serial Bus (USB) ports are for USB 3.0 devices.



- Due to the limitation of USB 3.0 controller, USB 3.0 devices can only be used under Windows OS environment and after the USB 3.0 driver installation.
- We strongly recommend that you connect USB 3.0 devices to USB 3.0 ports for faster and better performance from your USB 3.0 devices.

- 9. USB 5Gb/s Type C port.** This 24-pin Universal Serial Bus (USB) port is for USB (Type C) devices.
- 10. HDMI port.** This port is for a High-Definition Multimedia Interface (HDMI) connector, and is HDCP compliant allowing playback of HD DVD, Blu-ray, and other protected content.
- 11. DVI-D port.** This port is for any DVI-D compatible device.



DVI-D can not be converted to output from RGB Signal to CRT and is not compatible with DVI-I.

- 12. PS/2 keyboard port (purple).** This port is for a PS/2 keyboard.



## 1.7.2 Internal connectors

### 1. Serial port connector (10-1 pin COM)

This connector is for a serial (COM) port. Connect the serial port module cable to this connector, then install the module to a slot opening at the back of the system chassis.

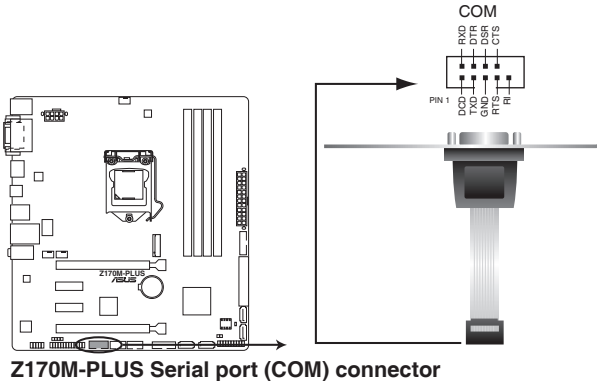

The COM module is purchased separately.

### 2. USB 2.0 connectors (10-1 pin USB1112, USB1314)

These connectors are for USB 2.0 ports. Connect the USB module cable to any of these connectors, then install the module to a slot opening at the back of the system chassis. These USB connectors comply with USB 2.0 specifications and supports up to 480Mbps connection speed.

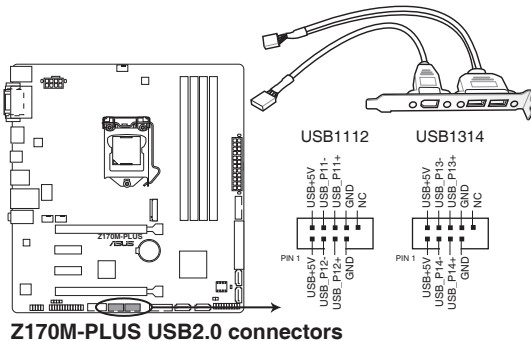

Never connect a 1394 cable to the USB connectors. Doing so will damage the motherboard!



The USB 2.0 module is purchased separately.

### 3. USB 3.0 connectors (20-1 pin USB3\_12, USB3\_34)

These connectors allow you to connect a USB 3.0 module for additional USB 3.0 front or rear panel ports. With an installed USB 3.0 module, you can enjoy all the benefits of USB 3.0 including faster data transfer speeds of up to 5 Gbps, faster charging time for USB-chargeable devices, optimized power efficiency, and backward compatibility with USB 2.0.

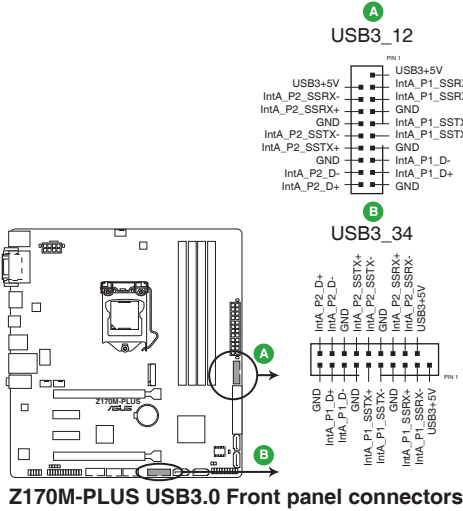

**Z170M-PLUS USB3.0 Front panel connectors**



The USB 3.0 module is purchased separately.

#### 4. ATX power connectors (24-pin EATXPWR, 8-pin ATX12V)

These connectors are for ATX power supply plugs. The power supply plugs are designed to fit these connectors in only one orientation. Find the proper orientation and push down firmly until the connectors completely fit.

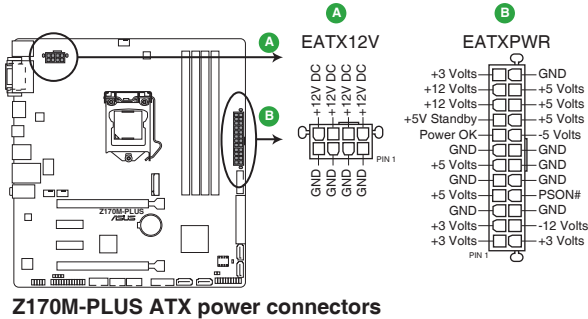

- For a fully configured system, we recommend that you use a power supply unit (PSU) that complies with ATX 12 V Specification 2.0 (or later version) and provides a minimum power of 350 W.
- DO NOT forget to connect the 4-pin/8-pin ATX +12V power plug. Otherwise, the system will not boot up.
- We recommend that you use a PSU with higher power output when configuring a system with more power-consuming devices or when you intend to install additional devices. The system may become unstable or may not boot up if the power is inadequate.
- If you want to use two or more high-end PCI Express x16 cards, use a PSU with 1000W power or higher to ensure the system's stability.
- If you are uncertain about the minimum power supply requirement for your system, refer to the Recommended Power Supply Wattage Calculator at <http://support.asus.com/PowerSupplyCalculator/PSCalculator.aspx?SLanguage=en-us> for details.

### 5. Front panel audio connector (10-1 pin AAFP)

This connector is for a chassis-mounted front panel audio I/O module that supports either HD Audio or legacy AC'97 audio standard. Connect one end of the front panel audio I/O module cable to this connector.

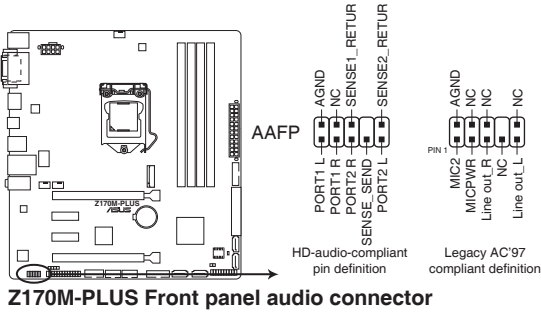

- We recommend that you connect a high-definition front panel audio module to this connector to avail of the motherboard's high-definition audio capability.
- If you want to connect a high-definition front panel audio module to this connector, set the Front Panel Type item in the BIOS setup to [HD]. If you want to connect an AC'97 front panel audio module to this connector, set the item to [AC97]. By default, this connector is set to [HD].

### 6. LPT connector (26-1 pin LPT)

The LPT (Line Printing Terminal) connector supports devices such as a printer. LPT standardizes as IEEE 1284, which is the parallel port interface on IBM PC-compatible computers.

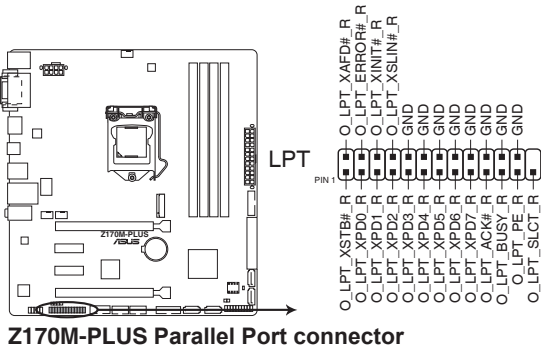

## 7. M.2 socket 3

This socket allows you to install an M.2 (NGFF) SSD module.

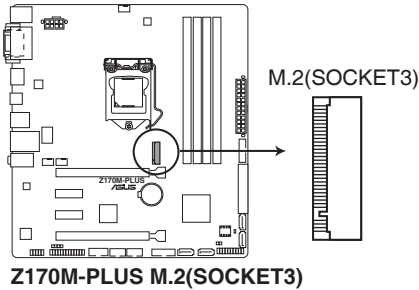

- This socket supports M Key and 2242/2260/2280 storage devices.
- The M.2 slot supports data transfer speed up to 32Gb/s.
- M.2 socket and SATA Express connector support PCIe and SATA devices in PCIe and SATA modes.
- When a device in PCIe mode is installed on the M.2 socket, SATA Express supports devices in both PCIe and SATA modes.
- When a device in SATA mode is installed on the M.2 socket, SATA Express supports one PCIe mode device or one SATA mode device (installed on SATA6G\_2 connector only). In this setup, the system sets a higher priority for M.2 socket than the SATA Express connector.



The M.2 (NGFF) SSD module is purchased separately

**8. Digital audio connector (4-1 pin SPDIF\_OUT)**

This connector is for an additional Sony/Philips Digital Interface (S/PDIF) port. Connect the S/PDIF Out module cable to this connector, then install the module to a slot opening at the back of the system chassis.

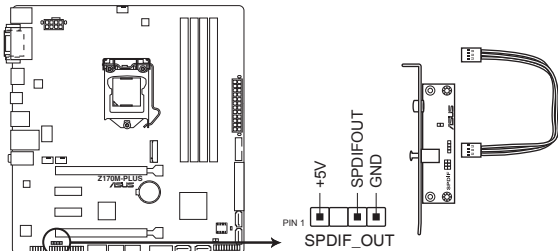

**Z170M-PLUS Digital audio connector**

**9. CPU and chassis fan connectors (4-pin CPU\_FAN, 4-pin CHA\_FAN 1/2)**

Connect the fan cables to the fan connectors on the motherboard, ensuring that the black wire of each cable matches the ground pin of the connector

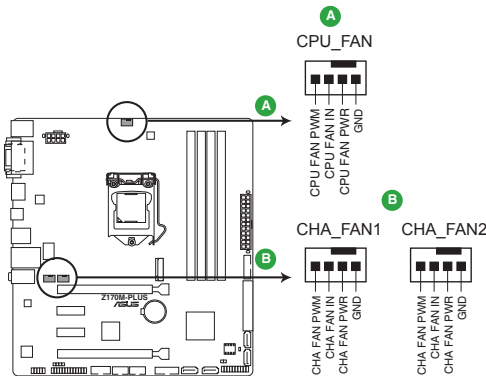

**Z170M-PLUS Fan connectors**



Do not forget to connect the fan cables to the fan connectors. Insufficient air flow inside the system may damage the motherboard components. These are not jumpers! Do not place jumper caps on the fan connectors! The CPU\_FAN connector supports a CPU fan of maximum 1A (12 W) fan power.



Only the 4-pin CPU fan supports the ASUS FAN Xpert 3 feature.

## 11. Intel® Z170 Serial ATA 6.0Gb/s connectors (7-pin SATA6G\_1-6, SATAEXPRESS)

These connectors connect to Serial ATA 6.0 Gb/s hard disk drives via Serial ATA 6.0 Gb/s signal cables.

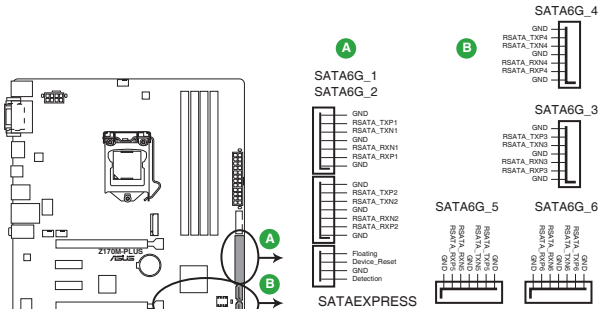

**Z170M-PLUS Intel® SATA 6.0Gb/s connectors**

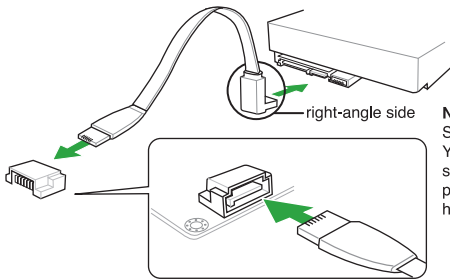

**NOTE:** Connect the right-angle side of SATA signal cable to SATA device. You may also connect the right-angle side of SATA cable to the onboard SATA port to avoid mechanical conflict with huge graphics cards.



When using hot-plug and NCQ, set the **SATA Mode Selection** item in the BIOS to [AHCI]. See section **2.6.5 SATA Configuration** for details.



- M.2 socket and SATA Express connector support PCIe and SATA devices in PCIe and SATA modes.
- When a device in PCIe mode is installed on the M.2 socket, SATA Express supports devices in both PCIe and SATA modes.
- When a device in SATA mode is installed on the M.2 socket, SATA Express supports one PCIe mode device or one SATA mode device (installed on SATA6G\_2 connector only). In this setup, the system sets a higher priority for M.2 socket than the SATA Express connector.
- The SATA EXPRESS connector can support one SATA Express device or at most two SATA devices.

## 12. System panel connector (20-5 pin PANEL)

This connector supports several chassis-mounted functions.

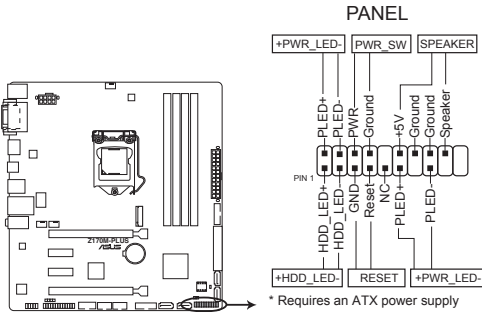

**Z170M-PLUS System panel connector**

- **System power LED (4-pin +PWR\_LED-)**

This 2-pin connector is for the system power LED. Connect the chassis power LED cable to this connector. The system power LED lights up when you turn on the system power, and blinks when the system is in sleep mode.

- **Hard disk drive activity LED (2-pin +HDD\_LED-)**

This 2-pin connector is for the HDD Activity LED. Connect the HDD Activity LED cable to this connector. The HDD LED lights up or flashes when data is read from or written to the HDD.

- **System warning speaker (4-pin SPEAKER)**

This 4-pin connector is for the chassis-mounted system warning speaker. The speaker allows you to hear system beeps and warnings.

- **ATX power button/soft-off button (2-pin PWR\_SW)**

This connector is for the system power button. Pressing the power button turns the system on or puts the system in sleep or soft-off mode depending on the operating system settings. Pressing the power switch for more than four seconds while the system is ON turns the system OFF.

- **Reset button (2-pin RESET)**

This 2-pin connector is for the chassis-mounted reset button for system reboot without turning off the system power.



## 1.8 Onboard LED

### 1. Standby Power LED (SB\_PWR)

The motherboard comes with a standby power LED that lights up to indicate that the system is ON, in sleep mode, or in soft-off mode. This is a reminder that you should shut down the system and unplug the power cable before removing or plugging in any motherboard component. The illustration below shows the location of the onboard LED.

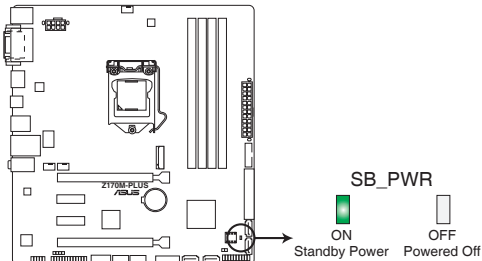

**Z170M-PLUS Standby power LED**

## 1.9 Software support

### 1.9.1 Installing an operating system

This motherboard supports Windows® 7 (64-bit/32-bit), Windows® 8.1 (64-bit) and Windows® 10 (64-bit) Operating Systems (OS). Always install the latest OS version and corresponding updates to maximize the features of your hardware.



Motherboard settings and hardware options vary. Refer to your OS documentation for detailed information.

### 1.9.2 Support DVD information

The Support DVD that comes with the motherboard package contains the drivers, software applications, and utilities that you can install to avail all motherboard features.



The contents of the Support DVD are subject to change at any time without notice. Visit the ASUS website at [www.asus.com](http://www.asus.com) for updates.

#### To run the Support DVD

Place the Support DVD into the optical drive. If Autorun is enabled in your computer, the DVD automatically displays the lists of the unique features of your ASUS motherboard. Click the **Drivers**, **Utilities**, **AHCI/RAID Driver**, **Manual**, **Contact**, or **Specials** tabs to display their respective menus.



The following screen is for reference only.

Click a tab to display Support DVD information

Driver	Status	Available Version	Installed Version	Restart
Special Offers				
Google Chrome Browser	Not installed	38.0.2125.92	None	No
Google Toolbar	Not installed	7.5.4501.1952	None	No
Driver				
Microsoft .NET Framework	Updated	4.5.51650	4.5.51650	No
Intel Chipset Driver	Updated	10.0.27	10.0.27	No
Realtek Audio Driver	Updated	6.0.1.7503	6.0.1.7503	No
Intel Graphics Accelerator Driver	Updated	10.18.15.4225	10.18.15.4225	No
Management Engine Interface	Updated	11.0.0.1137	11.0.0.1137	No
Intel Rapid Storage Technology Driver so...	Updated	14.5.0.1059	14.5.0.1059	No
Intel USB 3.0 Host Controller Adaptation ...	Updated	1.0.0.42	1.0.0.42	No
Realtek LAN Driver	Updated	8.38.115.2015	8.38.115.2015	No
APRP Utility	Not installed	1.0.026	None	No
Norton Internet Security	Not installed	21.6.0.32	None	No

Select an item/subitem that you want to install

Click to install



If Autorun is NOT enabled in your computer, browse the contents of the Support DVD to locate the file ASSETUP.EXE from the BIN folder. Double-click the ASSETUP.EXE to run the DVD.

# BIOS information

# 2

## 2.1 Managing and updating your BIOS



Save a copy of the original motherboard BIOS file to a USB flash disk in case you need to restore the BIOS in the future. Copy the original motherboard BIOS using the ASUS Update utility.

### 2.1.1 EZ Update

EZ Update is a utility that allows you to automatically update your motherboard's softwares, drivers and the BIOS version easily. With this utility, you can also manually update the saved BIOS and select a boot logo when the system goes into POST.

To launch EZ Update, click **EZ Update** on the AI Suite 3 main menu bar.

The screenshot shows the ASUS EZ Update utility window. It has a dark background with white text. On the left, there are two main sections: 'Check updates from internet' with a 'Check Now' button, and 'Manually update BIOS logs or BIOS' with a file selection button. On the right, there is a 'Current BIOS' section showing model name, version, and release date, and a 'Selected BIOS' section. Three red arrows point from text annotations to the 'Check Now' button, the file selection button, and the 'Update' button at the bottom right.

Click to automatically update your motherboard's driver, software and firmware

Click to find and select the BIOS from file

Click to select a boot logo

Click to update the BIOS



EZ Update requires an Internet connection either through a network or an ISP (Internet Service Provider).

## 2.1.2 ASUS EZ Flash 3

The ASUS EZ Flash 3 feature allows you to update the BIOS without using an OS-based utility.



- Ensure that you load the BIOS default settings to ensure system compatibility and stability. Select the **Load Optimized Defaults** item under the Exit menu. See section **2.10 Exit Menu** for details.
- Check your Internet connection before updating the BIOS via the Internet.

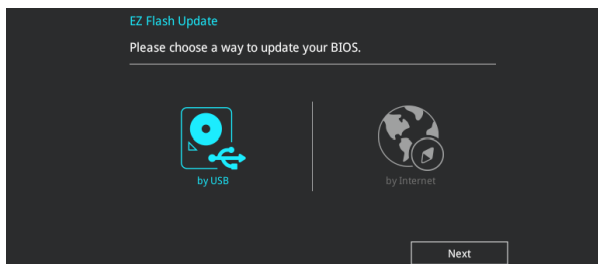

### To update the BIOS using EZ Flash 3:

1. Enter the **Advanced Mode** of the BIOS setup program. Go to the **Tool** menu to select **ASUS EZ Flash 3 Utility** and press <Enter> to enable it.
2. Follow the steps below to update the BIOS via USB or Internet.

#### Via USB

- a) Insert the USB flash disk that contains the latest BIOS file to the USB port, then select **by USB**.
- b) Press <Tab> to switch to the **Drive** field.
- c) Press the Up/Down arrow keys to find the USB flash disk that contains the latest BIOS, and then press <Enter>.
- d) Press <Tab> to switch to the **Folder Info** field.
- e) Press the Up/Down arrow keys to find the BIOS file, and then press <Enter> to perform the BIOS update process.

#### Via the Internet

- a) Select **by Internet**.
- b) Press the Left/Right arrow keys to select an Internet connection method, and then press <Enter>.
- c) Follow the onscreen instructions to complete the update.

3. Reboot the system when the update process is done.



- ASUS EZ Flash 3 supports USB devices, such as a USB flash disk, with FAT 32/16 format and single partition only.
- DO NOT shut down or reset the system while updating the BIOS to prevent system boot failure!

### 2.1.3 ASUS CrashFree BIOS 3 utility

The ASUS CrashFree BIOS 3 is an auto recovery tool that allows you to restore the BIOS file when it fails or gets corrupted during the updating process. You can restore a corrupted BIOS file using the motherboard support DVD or a USB flash drive that contains the updated BIOS file.



- Before using this utility, rename the BIOS file in the removable device into **Z170MP.CAP**.
- The BIOS file in the support DVD may not be the latest version. Download the latest BIOS file from the ASUS website at [www.asus.com](http://www.asus.com).

## Recovering the BIOS

### To recover the BIOS:

1. Turn on the system.
2. Insert the support DVD to the optical drive or the USB flash drive that contains the BIOS file to the USB port.
3. The utility automatically checks the devices for the BIOS file. When found, the utility reads the BIOS file and enters ASUS EZ Flash 3 utility automatically.
4. The system requires you to enter BIOS Setup to recover BIOS settings. To ensure system compatibility and stability, we recommend that you press <F5> to load default BIOS values.



DO NOT shut down or reset the system while updating the BIOS! Doing so can cause system boot failure!

### 2.1.4 ASUS BIOS Updater

ASUS BIOS Updater allows you to update the BIOS in DOS environment.



The screen captures used in this section are for reference only and may not be exactly the same as actually shown on your computer screen.

## Before updating BIOS

- Prepare the motherboard support DVD and a USB flash drive.
- Download the latest BIOS file and BIOS Updater from <http://support.asus.com> and save them in your USB flash drive.



---

NTFS is not supported under FreeDOS environment. Ensure that your USB flash drive is in single partition and in FAT32/16 format.

---

- Turn off the computer.
- Ensure that your computer has a DVD optical drive.

## Booting the system in DOS environment

### To boot the system in DOS:

1. Insert the USB flash drive with the latest BIOS file and BIOS Updater to the USB port.
2. Boot your computer then press <F8> to launch the select boot device screen.
3. When the select boot device screen appears, insert the Support DVD into the optical drive then select the optical drive as the boot device.

#### Please select boot device:

↑ and ↓ to move selection  
ENTER to select boot device  
ESC to boot using defaults

---

```
P2: ST3808110AS (76319MB)
aigo miniking (250MB)
UEFI: (FAT) ASUS DRW-2014L1T(4458MB)
P1: ASUS DRW-2014L1T(4458MB)
UEFI: (FAT) aigo miniking (250MB)
Enter Setup
```

4. When the booting message appears, press <Enter> within five (5) seconds to enter FreeDOS prompt.

```
ISOLINUX 3.20 2006-08-26 Copyright (C) 1994-2005 H. Peter Anvin
A Bootable DVD/CD is detected. Press ENTER to boot from the DVD/CD.
If no key is pressed within 5 seconds, the system will boot next priority
device automatically. boot:
```

5. On the FreeDOS prompt, type **d:** then press <Enter> to switch the disk from Drive C (optical drive) to Drive D (USB flash drive).

```
Welcome to FreeDOS (http://www.freedos.org) !
C: /> d:
D: />
```

## Updating the BIOS file

### To update the BIOS file:

1. On the FreeDOS prompt, type **bupdater /pc /g** and press <Enter>.

```
D: /> bupdater /pc /g
```

2. On the BIOS Updater screen, press <Tab> to switch from Files panel to Drives panel then select **D:**.

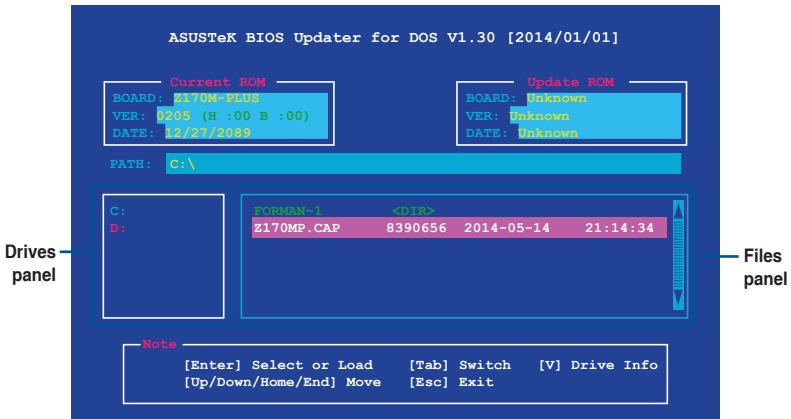

3. Press <Tab> to switch from Drives panel to Files panel then press <Up/Down or Home/End> keys to select the BIOS file and press <Enter>.
4. After the BIOS Updater checks the selected BIOS file, select **Yes** to confirm the BIOS update.



The BIOS Backup feature is not supported due to security regulations.

5. Select **Yes** then press <Enter>. When BIOS update is done, press <ESC> to exit BIOS Updater.
6. Restart your computer.



DO NOT shut down or reset the system while updating the BIOS to prevent system boot failure.



Ensure to load the BIOS default settings to ensure system compatibility and stability. Select the **Load Optimized Defaults** item under the **Exit BIOS Menu** for details.

## 2.2 BIOS setup program

Use the BIOS Setup program to update the BIOS or configure its parameters. The BIOS screens include navigation keys and brief online help to guide you in using the BIOS Setup program.

### Entering BIOS Setup at startup

#### To enter BIOS Setup at startup:

Press <Delete> or <F2> during the Power-On Self Test (POST). If you do not press <Delete> or <F2>, POST continues with its routines.

### Entering BIOS Setup after POST

#### To enter BIOS Setup after POST:

Press <Ctrl>+<Alt>+<Del> simultaneously.

Press the reset button on the system chassis.

Press the power button to turn the system off then back on. Do this option only if you failed to enter BIOS Setup using the first two options.



---

Using the power button, reset button, or the <Ctrl>+<Alt>+<Del> keys to force reset from a running operating system can cause damage to your data or system. We recommend you always shut down the system properly from the operating system.

---



- The BIOS setup screens shown in this section are for reference purposes only, and may not exactly match what you see on your screen.
  - Visit the ASUS website at [www.asus.com](http://www.asus.com) to download the latest BIOS file for this motherboard.
  - Ensure that a USB mouse is connected to your motherboard if you want to use the mouse to control the BIOS setup program.
  - If the system becomes unstable after changing any BIOS setting, load the default settings to ensure system compatibility and stability. Select the **Load Optimized Defaults** item under the Exit menu or press hotkey F5. See section 2.10 Exit Menu for details.
  - If the system fails to boot after changing any BIOS setting, try to clear the CMOS and reset the motherboard to the default value. See section 1.6 Headers for information on how to erase the RTC RAM.
- 

### BIOS menu screen

The BIOS setup program can be used under two modes: **EZ Mode** and **Advanced Mode**. Press <F7> to change between the two modes.



## 2.2.1 EZ Mode

By default, the EZ Mode screen appears when you enter the BIOS setup program. The EZ Mode provides you an overview of the basic system information, and allows you to select the display language, system performance mode, fan profile and boot device priority. To access the Advanced Mode, click **Advanced Mode(F7)** or press <F7>.



The default screen for entering the BIOS setup program can be changed. Refer to the **Setup Mode** item in section 2.8 **Boot menu** for details.

Displays the CPU/motherboard temperature, CPU voltage output, CPU/chassis fan speed, and SATA information

Selects the display language of the BIOS setup program

Displays the system properties of the selected mode. Click <Enter> to switch EZ System Tuning modes

Creates storage RAID and configures system overclocking

Enables or disables the Intel Rapid Storage Technology

Displays the CPU Fan's speed. Click the button to manually tune the fans

Loads optimized default settings

Saves the changes and resets the system

Shows the bootable devices

Displays the Advanced mode menus

Scan for more on FAQ page

Selects the boot device priority



The boot device options vary depending on the devices you installed to the system.

## 2.2.2 Advanced Mode

The Advanced Mode provides advanced options for experienced end-users to configure the BIOS settings. The figure below shows an example of the **Advanced Mode**. Refer to the following sections for the detailed configurations.



To access the EZ Mode, click **EzMode(F7)** or press <F7>.

The screenshot shows the ASUS UEFI BIOS Utility in Advanced Mode. The interface is dark-themed with blue and white text. At the top, there is a menu bar with options: My Favorites, Main, Ai Tweaker, **Advanced**, Monitor, Boot, Tool, and Exit. Below the menu bar, there are several sections: CPU C3 Report, CPU C6 Report, C-State Auto Demotion, C-State Un-demotion, Package C state demotion, Package C state undemotion, CState Pre-Wake, Package C State limit, and CFG lock. To the right, there is a Hardware Monitor section showing CPU and Memory status. At the bottom, there are Power Limit 3 and 4 Settings sections. The interface is annotated with red lines and labels pointing to various elements.

**Labels and Callouts:**

- Menu bar:** Points to the top navigation bar.
- Language:** Points to the language selection icon.
- MyFavorite:** Points to the My Favorites icon.
- Q-Fan control:** Points to the Q-Fan Control icon.
- EZ Tuning Wizard:** Points to the EZ Tuning Wizard icon.
- Quick Note:** Points to the Quick Note icon.
- Hot Keys:** Points to the Hot Keys icon.
- Sub-menu item:** Points to the Power Limit 3 Settings dropdown.
- Menu items:** Points to the list of menu items in the top bar.
- General help:** Points to the help icon.
- Configuration fields:** Points to the dropdown menus in the CPU C3 Report section.
- Scroll bar:** Points to the vertical scrollbar on the right side of the CPU C3 Report section.
- Last modified settings:** Points to the Last Modified field at the bottom right.
- Goes back to EZ Mode:** Points to the EzMode(F7) button at the bottom right.
- Displays the CPU/motherboard temperature, CPU and memory voltage output:** Points to the Hardware Monitor section on the right.

## Menu bar

The menu bar on top of the screen has the following main items:

<b>My Favorites</b>	For saving the frequently-used system settings and configuration
<b>Main</b>	For changing the basic system configuration
<b>Ai Tweaker</b>	For changing the overclocking settings
<b>Advanced</b>	For changing the advanced system settings
<b>Monitor</b>	For displaying the system temperature, power status, and changing the fan settings
<b>Boot</b>	For changing the system boot configuration
<b>Tool</b>	For configuring options for special functions
<b>Exit</b>	For selecting the exit options and loading default settings

## Menu items

The highlighted item on the menu bar displays the specific items for that menu. For example, selecting **Main** shows the Main menu items.

The other items (**My Favorites**, **Ai Tweaker**, **Advanced**, **Monitor**, **Boot**, **Tool**, and **Exit**) on the menu bar have their respective menu items.

## Submenu items

A greater than sign (>) before each item on any menu screen means that the item has a submenu. To display the submenu, select the item and press <Enter>.

## Language

This button above the menu bar contains the languages that you can select for your BIOS. Click this button to select the language that you want to display in your BIOS screen.

## MyFavorites (F3)

This button above the menu bar shows all BIOS items in a Tree Map setup. Select frequently-used BIOS settings and save it to MyFavorites menu.



---

Refer to section **2.3 My Favorites** for more information.

---

## Q-Fan Control (F6)

This button above the menu bar displays the current settings of your fans. Use this button to manually tweak the fans to your desired settings.



---

Refer to section **2.2.3 QFan Control** for more information.

---

## EZ Tuning Wizard (F11)

This button above the menu bar allows you to view and tweak the overclocking settings of your system. It also allows you to change the motherboard's SATA mode from AHCI to RAID mode.



---

Refer to section **2.2.4 EZ Tuning Wizard** for more information.

---

## Search on FAQ

Move your mouse over this button to show a QR code. Scan this QR code with your mobile device to connect to the ASUS BIOS FAQ web page. You can also scan the QR code below.



## Quick Note (F9)

This button above the menu bar allows you to key in notes of the activities that you have done in BIOS.



- 
- The Quick Note function does not support the following keyboard functions: delete, cut, copy and paste.
  - You can only use the alphanumeric characters to enter your notes.
- 

## Hot keys

This button above the menu bar contains the navigation keys for the BIOS setup program. Use the navigation keys to select items in the menu and change the settings.

## Scroll bar

A scroll bar appears on the right side of a menu screen when there are items that do not fit on the screen. Press the Up/Down arrow keys or <Page Up> / <Page Down> keys to display the other items on the screen.

## General help

At the top right corner of the menu screen is a brief description of the selected item. Use <F12> key to capture the BIOS screen and save it to the removable storage device.

## Configuration fields

These fields show the values for the menu items. If an item is user-configurable, you can change the value of the field opposite the item. You cannot select an item that is not user-configurable.

A configurable field is highlighted when selected. To change the value of a field, select it and press <Enter> to display a list of options.

## Last Modified button

This button shows the items that you last modified and saved in BIOS Setup.

## 2.2.3 QFan Control

The QFan Control allows you to set a fan profile or manually configure the operating speed of your CPU and chassis fans.

**Click to select a fan to be configured**

**Click to activate PWM Mode**

**Click to activate DC Mode**

**Q-Fan Control**  
Select your target fan and then move the slider to select any of these profiles: Standard, Silent, Turbo and Full Speed. You can also move the slider to Manual and manually configure the fan's operating speed.

Optimize All  
CPU FAN  
CHA1 FAN  
CHA2 FAN

**Standard** Silent Turbo Full Speed Manual

**Undo** **Apply** **Exit (ESC)**

**Select a profile to apply to your fans**

**Click to undo the changes**

**Click to apply the fan setting**

**Click to go back to main menu**

ASUS UEFI BIOS Utility - Advanced Mode  
01/08/2014 Wednesday 17:15  
English MyFavorite(F3) Qfan Control(F6) EZ Tuning Wizard(F11) Quick Note(F9) Hot Keys

Version 2.17.1246. Copyright (C) 2015 American Megatrends, Inc. Last Modified EzMode(F7)

## Configuring fans manually

Select **Manual** from the list of profiles to manually configure your fans' operating speed.

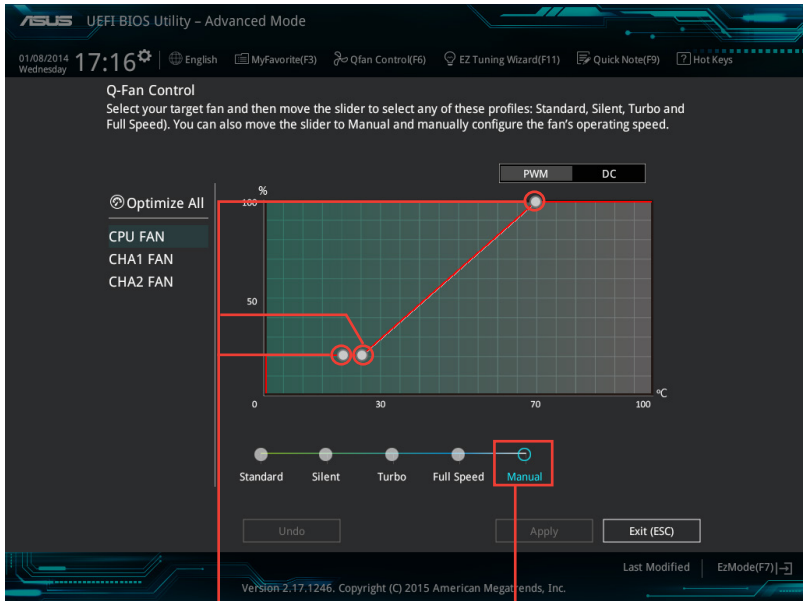

Speed points

Click to manually  
configure your fans

To configure your fans:

1. Select the fan that you want to configure and to view its current status.
2. Click and drag the speed points to adjust the fans' operating speed.
3. Click **Apply** to save the changes then click **Exit (ESC)**.

## 2.2.4 EZ Tuning Wizard

EZ Tuning Wizard allows you to overclock your CPU and DRAM, computer usage, and CPU fan to their best settings. You can also easily set RAID in your system using this feature.

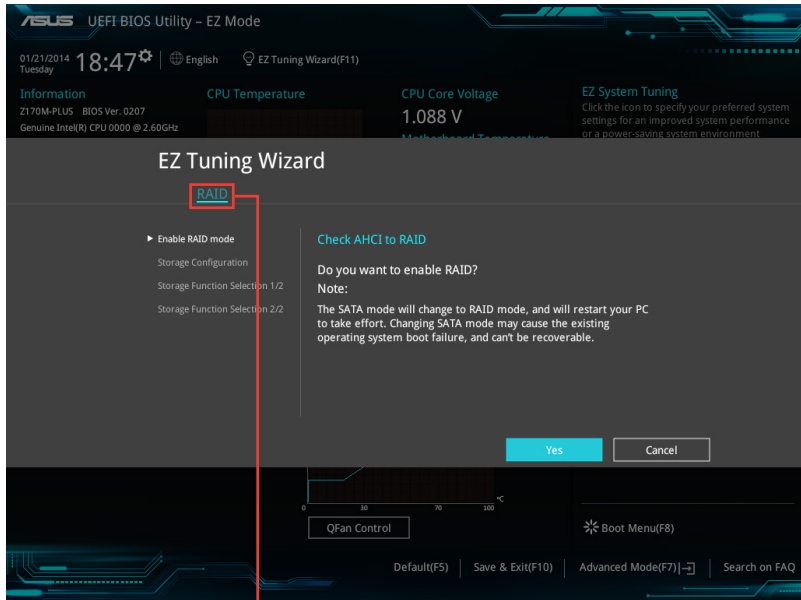

RAID setup

### Tuning your system settings

To tune your settings:

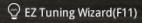
1. Press <F11> on your keyboard or click  from the BIOS screen to open EZ Tuning Wizard screen, then click **Next**.
2. Select a PC scenario **Daily Computing** or **Gaming/Media Editing**, then click **Next**.
3. Select the CPU fan type (**Box cooler**, **Tower cooler**, or **Water cooler**) that you installed then click **Next**.



If you are not sure of the CPU fan type, click **I'm not sure**. The system automatically detects the CPU fan type.

4. Click **Next** then click **Yes** to confirm auto-tuning.

## Creating RAID

To create RAID:

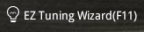
1. Press <F11> on your keyboard or click  from the BIOS screen to open EZ Tuning Wizard screen.
2. Click **RAID** then click **Next**.



- Ensure that your HDDs have no existing RAID volumes.
- Ensure to connect your HDDs to Intel® SATA connectors.

3. The available HDDs display. Click Next to continue.

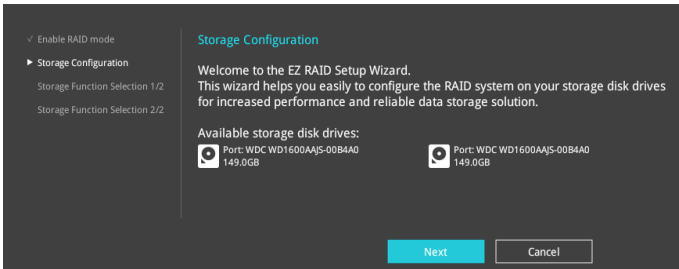

4. Select the type of storage for your RAID **Easy Backup** or **Super Speed**, then click **Next**.

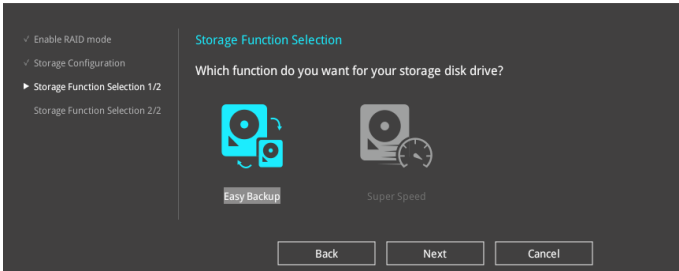



- a. For Easy Backup, select from **Easy Backup (RAID1)** or **Easy Backup (RAID10)** then click **Next**.

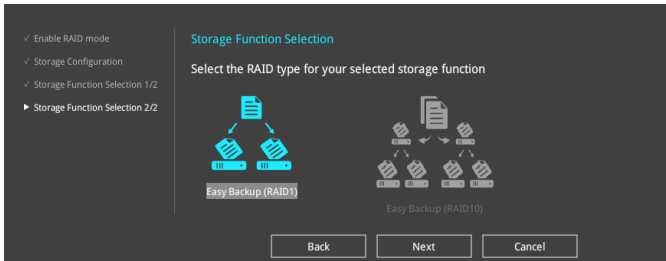

You can only select Easy Backup (RAID 10) if you connect four (4) HDDs.

- b. For Easy Backup, select from **Super Speed (RAID0)** or **Super Speed (RAID5)** then click **Next**.

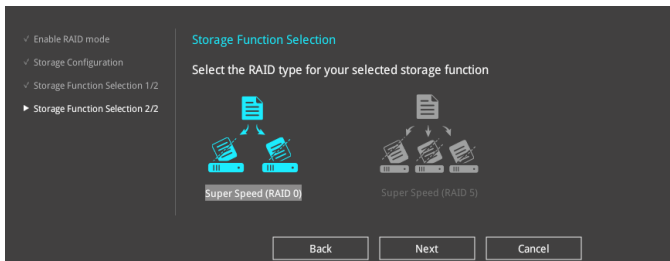

5. After selecting the type of RAID, click **Yes** to continue the RAID setup.
6. After the RAID setup is done, click **Yes** to exit the setup then click **OK** to reset your system.

## 2.3 My Favorites

MyFavorites is your personal space where you can easily save and access your favorite BIOS items.

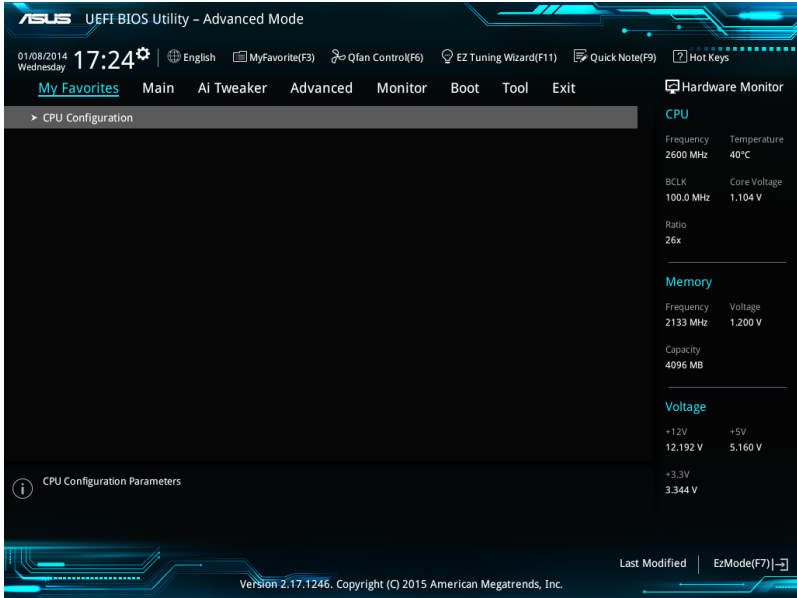

## Adding items to My Favorites

To add BIOS items:

1. Press <F3> on your keyboard or click  from the BIOS screen to open Setup Tree Map screen.
2. On the Setup Tree Map screen, select the BIOS items that you want to save in MyFavorites screen.

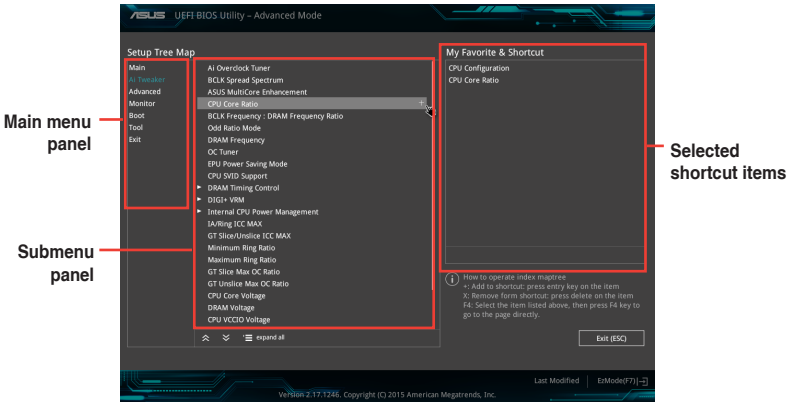

3. Select an item from main menu panel, then click the submenu that you want to save as favorite from the submenu panel and click .



You cannot add the following items to My Favorite items:

- User-managed items such as language and boot order

4. Click **Exit (ESC)** or press <esc> key to close Setup Tree Map screen.
5. Go to My Favorites menu to view the saved BIOS items.

## 2.4 Main menu

The Main menu screen appears when you enter the Advanced Mode of the BIOS Setup program. The Main menu provides you an overview of the basic system information, and allows you to set the system date, time, language, and security settings.

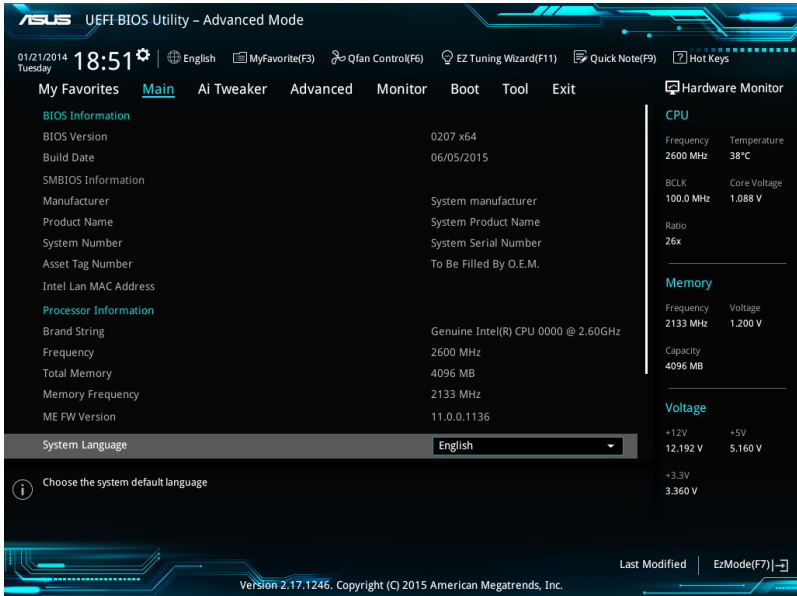

### 2.4.1 System Language [English]

Allows you to choose the BIOS language version from the options. Configuration options: [English] [Français] [Deutsch] [简体中文] [繁體中文] [日本語] [Español] [Русский] [한국어]

### 2.4.2 Security

The Security menu items allow you to change the system security settings.



- If you have forgotten your BIOS password, erase the CMOS Real Time Clock (RTC) RAM to clear the BIOS password. See section 1.6 Jumpers for information on how to erase the RTC RAM.
- The **Administrator** or **User Password** items on top of the screen show the default **Not Installed**. After you set a password, these items show **Installed**.

## Administrator Password

If you have set an administrator password, we recommend that you enter the administrator password for accessing the system.

### To set an administrator password:

1. Select the **Administrator Password** item and press <Enter>.
2. From the **Create New Password** box, key in a password, then press <Enter>.
3. Confirm the password when prompted.

### To change an administrator password:

1. Select the **Administrator Password** item and press <Enter>.
2. From the **Enter Current Password** box, key in the current password, then press <Enter>.
3. From the **Create New Password** box, key in a new password, then press <Enter>.
4. Confirm the password when prompted.

To clear the administrator password, follow the same steps as in changing an administrator password, but press <Enter> when prompted to create/confirm the password. After you clear the password, the **Administrator Password** item on top of the screen shows **Not Installed**.

## User Password

If you have set a user password, you must enter the user password for accessing the system. The **User Password** item on top of the screen shows the default **Not Installed**. After you set a password, this item shows **Installed**.

### To set a user password:

1. Select the **User Password** item and press <Enter>.
2. From the **Create New Password** box, key in a password, then press <Enter>.
3. Confirm the password when prompted.

### To change a user password:

1. Select the **User Password** item and press <Enter>.
2. From the **Enter Current Password** box, key in the current password, then press <Enter>.
3. From the **Create New Password** box, key in a new password, then press <Enter>.
4. Confirm the password when prompted.

To clear the user password, follow the same steps as in changing a user password, but press <Enter> when prompted to create/confirm the password. After you clear the password, the **User Password** item on top of the screen shows **Not Installed**.

## 2.5 Ai Tweaker menu

The Ai Tweaker menu items allow you to configure overclocking-related items.



Be cautious when changing the settings of the Ai Tweaker menu items. Incorrect field values can cause the system to malfunction.



The configuration options for this section vary depending on the CPU and DIMM model you installed on the motherboard.

Scroll down to display other BIOS items.

### 2.5.1 Ai Overclock Tuner [Auto]

This item allows you to select the CPU overclocking options to achieve the desired CPU internal frequency. Select any of these preset overclocking configuration options:

- [Auto] Loads the optimal settings for the system automatically.
- [Manual] Allows you to assign the BCLK (base clock) frequency manually.



The following items appear only when you set the Ai Overclocking Tuner to [Manual].

## BCLK Frequency [Auto]

This item appears only when you set **Ai Overclock Tuner** to [Manual] and allows you to set the BCLK (base clock) frequency to enhance the system performance. Use the <+> / <-> to adjust the value. The values range from 40.0 MHz to 500.0 MHz.



---

We recommend you to set the value based on the CPU specification, as high BCLK frequencies may damage the CPU permanently.

---

## BCLK Spread Spectrum [Auto]

This item allows you to enhance the BCLK overclocking capability or reduce the EMI (electromagnetic disturbance) generated by the BCLK. Set this item to [Enabled] for EMI reduction, or set this item to [Disabled] to enhance BCLK overclocking. Configuration options: [Auto] [Disabled] [Enabled]

## 2.5.2 ASUS MultiCore Enhancement [Auto]

[Auto] This item allows you to maximize the overlocking performance optimized by ASUS core ratio settings.

[Disabled] This item allows you to set to default core ratio settings.

## 2.5.3 CPU Core Ratio [Auto]

This item allows you to set the CPU core ratio limit per core or synchronize automatically to all cores. Configuration options: [Auto] [Sync All Cores] [Per Core]



---

When the **CPU Core Ratio** is set to [Sync All Cores] or [Per Core], the following items appear.

---

### 1-Core Ratio Limit [Auto]

Select **[Auto]** to apply the CPU default Turbo Ratio setting or manually assign a 1-Core Limit value that must be higher than or equal to the 2-Core Ratio Limit.

### 2-Core Ratio Limit [Auto]

Select **[Auto]** to apply the CPU default Turbo Ratio setting or manually assign a 2-Core Limit value that must be higher than or equal to the 3-Core Ratio Limit.



---

If you assign a value for 2-Core Ratio Limit, do not set the 1-Core Ratio Limit to **[Auto]**.

---

### 3-Core Ratio Limit [Auto]

Select **[Auto]** to apply the CPU default Turbo Ratio setting or manually assign a 3-Core Limit value that must be higher than or equal to the 4-Core Ratio Limit.



---

If you assign a value for 3-Core Ratio Limit, do not set the 1-Core Ratio Limit and 2-Core Ratio Limit to **[Auto]**.

---

### 4-Core Ratio Limit [Auto]

Select **[Auto]** to apply the CPU default Turbo Ratio setting or manually assign a 4-Core Limit value that must be higher than or equal to the 3-Core Ratio Limit.



---

If you assign a value for 4-Core Ratio Limit, do not set the 1-Core Ratio Limit, 2-Core Ratio Limit, and 3-Core Ratio to **[Auto]**.

---

## 2.5.4 BCLK Frequency: DRAM Frequency Ratio [Auto]

Allows you to set the CPU bus speed to DRAM speed ratio mode.

- [Auto]            DRAM speed is set to the optimized settings.  
[100:133]        The BCLK frequency to DRAM speed ratio is set to 100:133.  
[100:100]        The BCLK frequency to DRAM speed ratio is set to 100:100.

## 2.5.5 DRAM Odd Ratio Mode [Enabled]

Allows you to enable or disable the Odd Ratio Mode, which provides better granularity.  
Configuration options: [Disabled] [Enabled]

## 2.5.6 DRAM Frequency [Auto]

This item allows you to set the memory operating frequency. The configurable options vary with the BCLK (base clock) frequency setting. Select the auto mode to apply the optimized setting. Configuration options: [DDR4-800MHz] [DDR4-933MHz] [DDR4-1066MHz] [DDR4-1200MHz] [DDR4-1333MHz] [DDR4-1400MHz] [DDR4-1500MHz] [DDR4-1600MHz] [DDR4-1700MHz] [DDR4-1733MHz] [DDR4-1800MHz] [DDR4-1866MHz] [DDR4-1900MHz] [DDR4-2000MHz] [DDR4-2100MHz] [DDR4-2133MHz] [DDR4-2200MHz] [DDR4-2266MHz] [DDR4-2300MHz] [DDR4-2400MHz] [DDR4-2500MHz] [DDR4-2533MHz] [DDR4-2600MHz] [DDR4-2666MHz] [DDR4-2700MHz] [DDR4-2800MHz] [DDR4-2900MHz] [DDR4-2933MHz] [DDR4-3000MHz] [DDR4-3066MHz] [DDR4-3100MHz] [DDR4-3200MHz] [DDR4-3333MHz] [DDR4-3466MHz] [DDR4-3600MHz] [DDR4-3733MHz] [DDR4-3866MHz] [DDR4-4000MHz] [DDR4-4133MHz] [DDR4-4266MHz]



---

Selecting a very high memory frequency may cause the system to become unstable! If this happens, revert to the default setting.

---

## 2.5.7 OC Tuner [Keep Current Settings]

This item allows you to automatically overclock the CPU and DRAM frequencies and voltage for an enhanced system performance. It also accelerates the CPU graphics performance to the extreme depending on the CPU graphics loading. Configuration options: [Keep Current Settings] [Ratio First] [BCLK + Ratio Tuning]



---

Ensure that you installed an efficient CPU fan for CPU and graphics loading before selecting either **[BCLK + Ratio Tuning]** or **[Ratio First]**. To keep the current overclocking tuner status, select **[Keep Current Settings]**

---



## 2.5.8 EPU Power Saving Mode [Disabled]

ASUS EPU (Energy Processing Unit) sets the CPU in its minimum power consumption settings. Enable this item to set lower CPU VCCIN and Vcore voltages and achieve the best energy saving condition. Configuration options: [Disabled] [Enabled]

## 2.5.9 CPU SVID Support [Auto]

Disabling SVID Support stops the processor from communicating with the external voltage regulator. Configuration options: [Auto] [Disabled] [Enabled]

## 2.5.10 DRAM Timing Control

The subitems in this menu allow you to set the DRAM timing control features. Use the <+> and <-> keys to adjust the value. To restore the default setting, type [auto] using the keyboard and press the <Enter> key.



Changing the values in this menu may cause the system to become unstable! If this happens, revert to the default settings.

## 2.5.11 DIGI+ VRM

### CPU Load-Line Calibration [Auto]

Load-line is defined by Intel VRM specification and affects the CPU power voltage. The CPU working voltage will decrease proportionally depending on the CPU loading. Higher levels of the load-line calibration can get a higher voltage and a better overclocking performance but increases the CPU and VRM thermal. Configuration options: [Auto] [Level 1-8]



The boosted performance may vary depending on the CPU specification. Do not remove the thermal module.

### CPU Current Capability [Auto]

Allows you to configure the total power range, and extends the overclocking frequency range simultaneously. Configuration options: [Auto] [100%] [110%] [120%] [130%] [140%]



Choose a higher value when overclocking, or under a high CPU loading for extra power support.

### CPU VRM Switching Frequency [Auto]

This item affects the VRM transient response speed and the component thermal production. Select [Manual] to configure a higher frequency for a quicker transient response speed. Configuration options: [Auto] [Manual]



DO NOT remove the thermal module. The thermal conditions should be monitored.



The following item appears only when you set the **CPU VRM Switching Frequency** to **[Manual]**.

### Fixed CPU VRM Switching Frequency (KHz) [250]

This item allows you to set a higher frequency for a quicker transient response speed. Use the <+> and <-> keys to adjust the value. The values range from 300KHz to 600KHz with a 50KHz interval.

### CPU Power Duty Control [T.Probe]

DIGI + VRM Duty control adjusts the current and thermal conditions of every component's phase.

[T. Probe] Select to maintain the VRM thermal balance.

[Extreme] Select to maintain the current VRM balance.

### CPU Power Phase Control [Auto]

This item allows you to set the power phase control of the CPU. Configuration options: [Auto] [Standard] [Optimized] [Extreme] [Power Phase Response]



---

DO NOT remove the thermal module when setting this item to **[Power Phase Response]**. The thermal conditions should be monitored.

---



---

The following item appears only when you set the **CPU Power Phase Control** to **[Power Phase Response]**.

---

### Power Phase Response [Fast]

This item allows you to set a faster phase response for the CPU to increase system performance or to slower phase response to decrease DRAM power efficiency. Configuration options: [Ultra Fast] [Fast] [Medium] [Regular]

### CPU Graphics Load-line Calibration [Auto]

The load-line is defined by the Intel VRM specification and affects the GT power voltage. The GT working voltage will decrease proportionally depending on the GT loading. Higher levels of the load-line calibration can get a higher voltage and a better overclocking performance but increase the GT and VRM thermal production. Select from level 1 to 8 to adjust the GT power voltage from 0% to 100%.



---

The boosted performance may vary depending on the GT specification. Do not remove the thermal module.

---

### CPU Graphics Current Capability [Auto]

This item allows you to adjust the total power range for GT overclocking. A higher value provides a wider total power range and extends the overclocking frequency range simultaneously. Configuration options: [Auto] [100%] [110%] [120%] [130%] [140%]



---

Choose a higher value when overclocking, or under a high GT loading for extra power support.

---

### CPU Graphics [Auto]

This item affects the GT transient response speed and the component thermal production. Select [Manual] to configure a higher frequency for a quicker transient response speed. Configuration options: [Auto] [Manual]



---

DO NOT remove the thermal module. The thermal conditions should be monitored.

---



---

The following item appears only when you set the **CPU Graphics** to **[Manual]**.

---

### **Fixed VCCGT Switching Frequency (KHz) [250]**

This item allows you to set a higher frequency for a quicker transient response speed. Use the <+> and <-> keys to adjust the value. The values range from 300KHz to 600KHz with a 50KHz interval.

### **GT Power Duty Control [T.Probe]**

This item adjusts the current and thermal conditions of every component's phase.

[T. Probe] Select to maintain the VRM thermal balance.

[Extreme] Select to maintain the current VRM balance.

### **GT Power Phase Control [Auto]**

This item allows you to set the power phase control of the CPU. Configuration options: [Auto] [Standard] [Optimized] [Extreme] [Power Phase Response]



---

DO NOT remove the thermal module when setting this item to **[Power Phase Response]**. The thermal conditions should be monitored.

---



---

The following item appears only when you set the **GT Power Phase Control** to **[Power Phase Response]**.

---

### **Power Phase Response [Fast]**

Select [Ultra Fast] for a faster power phase response. The reaction time will be longer when [Regular] is selected. Configuration options: [Ultra Fast] [Fast] [Medium] [Regular]

## **2.5.12 Internal CPU Power Management**

The subitems in this menu allow you to set the CPU ratio and their features.

### **Intel(R) SpeedStep(tm) [Enabled]**

This item allows the operating system to dynamically adjust the processor voltage and cores frequency, resulting to a decreased average power consumption and decreased average heat production. Configuration options: [Disabled] [Enabled]

### **Turbo Mode [Enabled]**

This item allows you to enable your core processor's speed to run faster than the base operating frequency when it is below operating power, current and temperature specification limit. Configuration options: [Disabled] [Enabled]



---

The following items appear only when you set the Turbo Mode to **[Enabled]**.

---

## Turbo Mode Parameters

### Long Duration Package Power Limit [Auto]

Allows you to limit the Turbo Ratio's time duration that exceeds the TDP (Thermal Design Power) for maximum performance. Use the <+> or <-> keys to adjust the value. The values range from 1 W to 4095 W.

### Package Power Time Window [Auto]

Also known as Power Limit 1, this item allows you to maintain the time window for Turbo Ratio over TDP (Thermal Design Power). Use the <+> or <-> keys to adjust the value. The values range from 1 to 127 in seconds.

### Short Duration Package Power Limit [Auto]

Also known as Power Limit 2, this item allows you to provide rapid protection when the package power exceeds the Power Limit 1. Use the <+> or <-> keys to adjust the value. The values range from 1 W to 4095 W.

### IA AC Load Line [Auto]

This item allows you to set the AC loadline defined in 1/100 mOhms. Use the <+> and <-> keys to adjust the value.

Configuration options: [Auto] [0.01] - [62.49]

### IA DC Load Line [Auto]

This item allows you to set the DC loadline defined in 1/100 mOhms. Use the <+> and <-> keys to adjust the value.

Configuration options: [Auto] [0.01] - [62.49]

## 2.5.13 CPU Core/Cache Current Limit Max. [Auto]

Allows you to configure a higher CPU core/cache current limit to prevent a frequency or power throttling when overclocking.

## 2.5.14 CPU Graphics Current Limit Max. [Auto]

Allows you to configure a higher CPU graphics current limit to prevent a frequency or power throttling when overclocking.

## 2.5.15 Min. CPU Cache Ratio [Auto]

Allows you to configure the minimum possible CPU cache ratio.

## 2.5.16 Max. CPU Cache Ratio [Auto]

Allows you to configure the maximum possible CPU cache ratio.

## 2.5.17 Max. CPU Graphics Ratio [Auto]

Allows you to configure the maximum CPU graphics ratio.

## 2.5.18 CPU Core/Cache Voltage [Auto]

This item allows you to configure the amount of voltage fed to the CPU cores. Increase the voltage when setting a high Core Frequency value. Configuration options: [Auto] [Manual Mode] [Offset Mode] [Adaptive Mode]



- The following item appears only when you set the **CPU Core/Cache Voltage** to **[Manual Mode]**.
- **[Adaptive Mode]** is available for some specific CPU types.

### CPU Core Voltage Override [Auto]

Allows you to set the CPU Core Voltage override. Use the <+> or <-> keys to adjust the value. The values range from 0.600V to 1.700V with a 0.005V interval.



The following items appear only when you set the **CPU Core/Cache Voltage** to **[Offset Mode]** or **[Adaptive Mode]**.

### Offset Mode Sign [+]

[+] To offset the voltage by a positive value.

[-] To offset the voltage by a negative value.

### CPU Core Voltage Offset [Auto]

Use the <+> or <-> keys to adjust the value. The values range from 0.001V to 0.999V with a 0.001V interval.



The following item appears only when you set the **CPU Core/Cache Voltage** to **[Adaptive Mode]**.

### Additional Turbo Mode CPU Core Voltage [Auto]

This item allows you to set the amount of voltage fed to the CPU cores when running in turbo mode. Increase the voltage when configuring a high CPU core frequency. The voltage you set is affected by the offset value. Use the <+> or <-> keys to adjust the value. The values range from 0.25V to 1.920 V with a 0.001 V interval.

### Offset Voltage [Auto]

This item allows you to configure the CPU core voltage offset value. Use the <+> or <-> keys to adjust the value. The values range from 0.001V to 0.999 V with a 0.001 V interval.

### Total Adaptive Mode CPU Core Voltage [By CPU]

This item sums up the voltages of the CPU Core Voltage offset and Additional Turbo Mode CPU Core Voltage options.

### 2.5.19 DRAM Voltage [Auto]

Allows you to set the DRAM Voltage for the system memory. The values range from 1.000V to 1.800V with a 0.005V interval.

### 2.5.20 CPU VCCIO Voltage [Auto]

Allows you to set the value for the VCCIO voltage. The values range from 0.700V to 1.585V with a 0.005V interval.

### 2.5.21 CPU System Agent Voltage [Auto]

Allows you to set the value for the CPU system agent voltage. Use the <+> or <-> keys to adjust the value. The values range from 0.700V to 1.685V with a 0.005V interval.

### 2.5.22 CPU Graphics Voltage Mode [Auto]

Allows you to select the CPU graphics voltage mode.

[Manual Mode] Allows you to define the value.

[Offset Mode] The value is set by SVID.



---

The following item appears only when you set the **CPU Graphics Voltage Mode** to **[Manual Mode]**.

---

### CPU Graphics Voltage Override [Auto]

Allows you to set the CPU Graphics Voltage override. Use the <+> or <-> keys to adjust the value. The values range from 0.600V to 1.700V with a 0.005V interval.



---

The following items appear only when you set the **CPU Graphics Voltage Mode** to **[Offset Mode]**.

---

### Offset Mode Sign [+]

[+] To offset the voltage by a positive value.

[-] To offset the voltage by a negative value.

### CPU Graphics Voltage Offset [Auto]

Use the <+> or <-> keys to adjust the value. The values range from 0.001V to 0.635V with a 0.005V interval.

### 2.5.23 PCH Core Voltage [Auto]

Allows you to set the Platform Controller Hub voltage. Use the <+> or <-> keys to adjust the value. The values range from 1.0V to 1.15V with a 0.05V interval.



---

The system may need better cooling system to work stably under high voltage settings.

---

## 2.5.24 DRAM REF Voltage Control [Auto]

This item allows you to set the DRAM reference voltage on the control lines from the memory bus. You can use the <+> or <-> keys to adjust the value. The values range from 0.39500V to 0.63000V with a 0.00500V interval.

### **DRAM DATA REF Voltage on CHA [Auto]**

Allows you to set the DRAM DATA REF Voltage on CHA. The values range from 0.39500x to 0.63000x with a 0.00500x interval

### **DRAM DATA REF Voltage on CHB [Auto]**

Allows you to set the DRAM DATA REF Voltage on CHB. The values range from 0.39500x to 0.63000x with a 0.00500x interval

### **BRAM DATA REF Voltage on CHA DIMM0 Rank0 BL0~BL7 [Auto]**

Allows you to set the DRAM DATA REF Voltage on CHA DIMM0 Rank0 BL1~BL7.

### **BRAM DATA REF Voltage on CHA DIMM0 Rank1 BL0~BL7 [Auto]**

Allows you to set the DRAM DATA REF Voltage on CHA DIMM0 Rank1 BL1~BL7.

### **BRAM DATA REF Voltage on CHA DIMM1 Rank0 BL0~BL7 [Auto]**

Allows you to set the DRAM DATA REF Voltage on CHA DIMM1 Rank0 BL1~BL7.

### **BRAM DATA REF Voltage on CHA DIMM1 Rank1 BL0~BL7 [Auto]**

Allows you to set the DRAM DATA REF Voltage on CHA DIMM1 Rank1 BL1~BL7.

### **BRAM DATA REF Voltage on CHB DIMM0 Rank0 BL0~BL7 [Auto]**

Allows you to set the DRAM DATA REF Voltage on CHB DIMM0 Rank0 BL1~BL7.

### **BRAM DATA REF Voltage on CHB DIMM0 Rank1 BL0~BL7 [Auto]**

Allows you to set the DRAM DATA REF Voltage on CHB DIMM0 Rank1 BL1~BL7.

### **BRAM DATA REF Voltage on CHB DIMM1 Rank0 BL0~BL7 [Auto]**

Allows you to set the DRAM DATA REF Voltage on CHB DIMM1 Rank0 BL1~BL7.

### **BRAM DATA REF Voltage on CHB DIMM1 Rank1 BL0~BL7 [Auto]**

Allows you to set the DRAM DATA REF Voltage on CHB DIMM1 Rank1 BL1~BL7.

## 2.6 Advanced menu

The Advanced menu items allow you to change the settings for the CPU and other system devices.



Be cautious when changing the settings of the Advanced menu items. Incorrect field values can cause the system to malfunction.

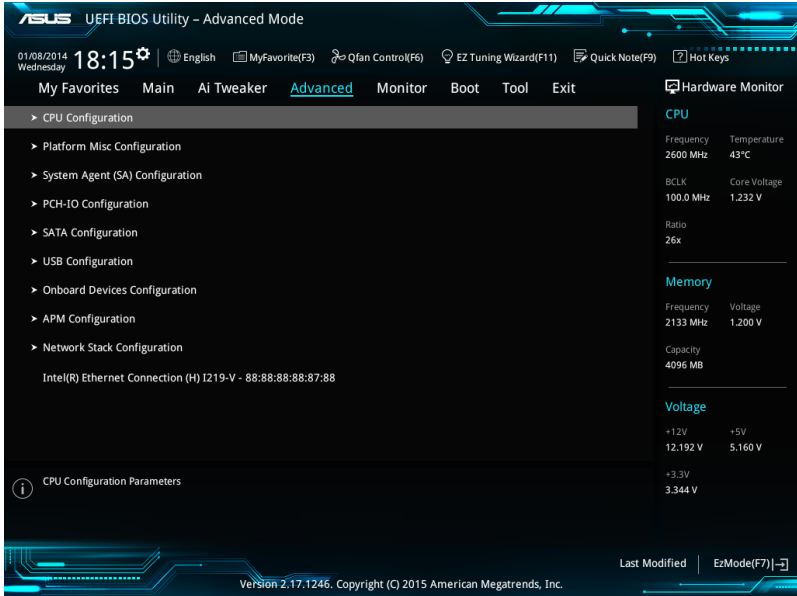

### 2.6.1 CPU Configuration

The items in this menu show the CPU-related information that the BIOS automatically detects.



The items shown in submenu may be different due to the CPU you installed.

#### Hyper-threading [Enabled]

The Intel Hyper-Threading Technology allows a hyper-threading processor to appear as two logical processors to the operating system, allowing the operating system to schedule two threads or processes simultaneously.

[Enabled] Two threads per activated core are enabled.

[Disabled] Only one thread per activated core is enabled.



## Active Processor Cores [All]

This item allows you to select the number of CPU cores to activate in each processor package. Configuration options: [All] [1] [2] [3]



---

For some CPU types, only [All] and [1] appear.

---

## Intel Virtualization Technology [Enabled]

When set to [Enabled], a VMM can utilize the additional hardware capabilities provided by Vanderpool Technology. Configuration options: [Disabled] [Enabled]

## Hardware Prefetcher [Enabled]

This item allows the CPU to prefetch commands and data in the L2 cache, reduces the DRAM loading time and improves the system performance. Configuration options: [Disabled] [Enabled]

## Adjacent Cache Line Prefetcher [Enabled]

This item allows the mid level cache (L2) to prefetch adjacent cache lines, reducing the DRAM loading time and improves the system performance. Configuration options: [Disabled] [Enabled]

## Boot Performance Mode [Auto]

This item allows you to select the CPU performance state during system boot before the operating system takes control. The CPU runs at a selected performance ratio based on CPU configuration. Configuration options: [Max Battery] [Max Non-Turbo Performance] [Turbo Performance] [Auto]

## CPU Power Management Configuration

### Intel® SpeedStep™ [Enabled]

This item allows more than two frequency rates to be supported. Configuration options: [Disabled] [Enabled]

### Turbo Mode [Enabled]

This item allows you to automatically set the CPU cores to run faster than the base operating frequency when it is below the operating power, current and temperature specification limit. Configuration options: [Enabled] [Disabled]



---

Turbo Mode is only available on selected CPU models only.

---

## CPU C-States [Auto]

This item allows you to set the power saving of the CPU states. Configuration options: [Auto] [Disabled] [Enabled]



---

The following items appear only when you set the CPU C-States to **[Enabled]**.

---

**Enhanced C states [Enabled]**

This item allows your CPU to reduce power consumption when the system is in idle mode. Configuration options: [Enabled] [Disabled]

**CPU C3/C6 Report [Enabled]**

Allows you to disable or enable the CPU C3/C6 report to OS. Configuration options: [Enabled] [Disabled]

**Package C State Limit [Auto]**

This item allows you to set the a C-state support for the CPU package. Configuration options: [Auto] [C0/C1] [C2] [C3] [C6] [C7] [C7s]

**CFG Lock [Enabled]**

This item allows you to configure MSR 0xE2[15], CFG lock bit. Configuration options: [Disabled] [Enabled]

## 2.6.2 Platform Misc Configuration

The items in this menu allow you to configure the platform-related features.

**PCI-E Native Power Management [Disabled]**

This item allows you to enhance the power saving feature of PCI Express and perform ASPM operations in the operating system. Configuration options: [Disabled] [Enabled]



---

The following item appears only when you set the PCI Express Native Power Management to **[Enabled]**.

---

**Native ASPM [Disabled]**

[Enabled] Windows® Vista OS controls the ASPM (active state power management) support for devices.

[Disabled] BIOS controls the ASPM support for the device.

**PCH - PCI Express options**

**DMI Link ASPM Control [Disabled]**

This item allows you to control the Active State Power Management on both NB (NorthBridge) side and SB (SouthBridge) side of the DMI Link. Configuration options: [Disabled] [Enabled]

**ASPM Support [Disabled]**

This item allows you to select the ASPM state for energy-saving conditions. Configuration options: [Disabled] [L0s] [L1] [L0sL1] [Auto]

## SA - PCI Express options

### DMI Link ASPM Control [Disabled]

This item allows you to control the Active State Power Management on both CPU and PCH (platform controller hub) Both DMI link ASPM control items of the CPU and PCH sides must be enabled for the ASPM to take effect. Configuration options: [Disabled] [L1]

### PEG ASPM [Disabled]

This item allows you to select the ASPM state for energy-saving conditions, or use the ASUS optimized energy saving profile. Configuration options: [Disabled] [Auto] [ASPM L0s] [ASPM L1] [ASPM L0sL1]

## 2.6.3 System Agent (SA) Configuration

### VT-d [Enabled]

Allows you to enable or disable VT-d function on MCH. Configuration options: [Enabled] [Disabled]

### Above 4GB MMIO BIOS assignment [Disabled]

Allows you to enable or disable the above 4 GB memory mapped IO BIOS assignment. Configuration options: [Enabled] [Disabled]

### Graphics Configuration

Allows you to select a primary display from CPU, PCIE and PCI graphical devices.

#### Primary Display [Auto]

Allows you to select the primary display from CPU, PCIE and PCI graphics devices. Configuration options: [Auto] [CPU Graphics] [PCIE]

#### iGPU Multi-Monitor [Disabled]

This item allows you to empower both integrated and discrete graphics devices for the multi-monitor output. The CPU graphics shared system memory size is fixed at 64 MB. Configuration options: [Disabled] [Enabled]

#### DVMT Pre-Allocated [32M]

Allows you to select DVMT 5.0 Pre-Allocated (Fixed) Graphics Memory size used by the Internal Graphics Device.

#### DVMT Total Gfx Mem [256M]

Allows you to select DVMT5.0 Total Graphic Memory size used by the Internal Graphics Device.

### DMI/OPI Configuration

This item allows you to control various DMI (direct media interface) to run at PCI-E 2.0 speed.

#### DMI Max Link Speed [Gen2]

Allows you to configure the DMI speed. Configuration options: [Auto] [Gen1] [Gen2] [Gen3]

## PEG Port Configuration

Allows you to configure the PEG Port settings.

### PCIEx16\_1 Link Speed [Auto]

Allows you to configure the PCIEx16 speed for slot 1. Configuration options: [Auto] [Gen1] [Gen2] [Gen3]

## Memory Configuration

Allows you to configure the memory configuration parameters.

### Memory Remap [Enabled]

Set this item to [Enabled] to support DRAM address remapping for 64-bit operating systems. Configuration options: [Enabled] [Disabled]

## 2.6.4 PCH-IO Configuration

This item allows you to configure the PCI Express configuration settings.

### PCI Express Configuration

Allows you to configure PCI Express settings.

#### PCIe Speed [Auto]

Allows you to configure the PCIe speed. Configuration options: [Auto] [Gen1] [Gen2] [Gen3]

## 2.6.5 SATA Configuration

While entering Setup, the BIOS automatically detects the presence of SATA devices. The SATA Port items show **Not Present** if no SATA device is installed to the corresponding SATA port.

### SATA Controller(s) [Enabled]

Enables or disables onboard the SATA device. Configuration options: [Disabled] [Enabled]

### SATA Mode Selection [AHCI]

Allows you to set the SATA configuration.

[AHCI] Set to [AHCI] when you want the SATA hard disk drives to use the AHCI (Advanced Host Controller Interface). The AHCI allows the onboard storage driver to enable advanced Serial ATA features that increases storage performance on random workloads by allowing the drive to internally optimize the order of commands.

[RAID] Set to [RAID Mode] when you want to create a RAID configuration from the SATA hard disk drives.



---

The following items appear only when you set the SATA Mode Selection to **[RAID]**.

---

#### **CR#1/2/3 RST Pcie Storage Remapping [Disabled]**

This item allows you to enable or disable the RST Pcie Storage Remapping feature.  
Configuration options: [Auto] [Disabled] [Enabled]

#### **Alternate ID [Disabled]**

This item allows you to enable or disable the report for the alternate device ID.  
Configuration options: [Auto] [Disabled] [Enabled]

### **SMART Self Test**

This item allows you to enable or disable the SMART Self Test on all HDDs during POST.

#### **SATA6G\_1/2/3/4/5/6 (Gray) [Enabled]**

Allows you to enable/disable the SATA6G\_1/2/3/4/5/6 port. Configuration options: [Disabled] [Enabled]

#### **Hot Plug [Disabled]**

These items allow you to enable/disable SATA Hot Plug Support. Configuration options: [Disabled] [Enabled]

## **2.6.6 USB Configuration**

The items in this menu allow you to change the USB-related features.



---

The **USB Devices** item shows the auto-detected values. If no USB device is detected, the item shows None.

---

#### **Legacy USB Support [Enabled]**

- [Enabled] Your system supports the USB devices in legacy operating systems.
- [Disabled] Your USB devices can be used for BIOS setup only and cannot be recognized in the boot devices list.
- [Auto] Your system automatically detects the presence of USB devices at startup. If any USB devices are detected, the legacy USB support is enabled.

#### **XHCI Hand-off [Disabled]**

- [Enabled] Enables the support for operating systems without an XHCI hand-off feature.
- [Disabled] Disables the XHCI Hand-off support.

## USB Port Disable Override

Allows you to selectively enable/disable the corresponding USB port from reporting a Device Connection to the controller.

### USB\_C1 [Enabled]

Allows you to enable/disable USB\_C1 port. Configuration options: [Disabled] [Enabled]

### USB\_1112/1314 [Enabled]

Allows you to enable/disable USB\_1112/1314 port. Configuration options: [Disabled] [Enabled]

### USB3\_12/34/78 [Enabled]

Allows you to enable/disable USB3\_12/34/78 port. Configuration options: [Disabled] [Enabled]

## 2.6.7 Onboard Devices Configuration

### HD Audio Controller [Enabled]

[Enabled] Enables the HD Audio Device.

[Disabled] Disables the HD Audio Device.



---

The following item appears only when you set the **HD Audio Controller** item to [Enabled].

---

### Front Panel Type [HD]

Allows you to set the front panel audio connector (AAFP) mode to legacy AC'97 or high-definition audio depending on the audio standard that the front panel audio module supports.

[HD] Sets the front panel audio connector (AAFP) mode to high definition audio.

[AC97] Sets the front panel audio connector (AAFP) mode to legacy AC'97

### SPDIF Out Type [SPDIF]

[SPDIF] Sets to an SPDIF audio output.

[HDMI] Sets to an HDMI audio output.

### M.2 and SATA Express SATA Mode Configuration [SATA Express]

M.2 shares SATA mode with SATA Express. This item allows you to change the SATA mode before you install M.2 SATA device.

[SATA Express] SATA mode will be switched to SATA Express. M.2 can only support PCIe devices.

[M.2] SATA mode will be switched to M.2. SATA Express can only support PCIe device.

### Intel LAN Controller [Enabled]

[Enabled] Enables the Intel LAN controller.

[Disabled] Disables the controller.

## Intel PXE Option ROM [Off]

This item appears only when you set the previous item to [Enabled] and allows you to enable or disable the PXE OptionRom of the Intel LAN controller. Configuration options: [On] [Off]

## Serial Port Configuration

The sub-items in this menu allow you to set the serial port configuration.

### Serial Port [On]

Allows you to enable or disable the serial port (COM). Configuration options: [On] [Off]

### Change Settings [IO=3F8h; IRQ=4]

This item appears only when you set the **Serial Port** to [Enabled] and allows you to select the Serial Port base address. Configuration options: [IO=3F8h; IRQ=4] [IO=2F8h; IRQ=3] [IO=3E8h; IRQ=4] [IO=2E8h; IRQ=3]

## Parallel Port Configuration

The sub-items in this menu allow you to set the parallel port configuration.

### Parallel Port [On]

Allows you to enable or disable the parallel port (LPT/LPTE). Configuration options: [On] [Off]



---

The following items appear only when you set the **Parallel Port Configuration** item to [Enabled].

---

### Change Settings [Auto]

Allows you to select an optimal setting for Super I/O devices. Configuration options: [Auto] [IO=378h; IRQ=5;] [IO=378h; IRQ=5,6,7,9,10,11,12;] [IO=278h; IRQ=5,6,7,9,10,11,12;] [IO=3BCh; IRQ=5,6,7,9,10,11,12;]

### Device Mode [STD Printer Mode]

Allows you to select the Printer Port mode. Configuration options: [STD Printer Mode] [SPP Mode] [EPP-1.9 and SPP Mode] [EPP-1.7 and SPP Mode] [ECP Mode] [ECP and EPP 1.9 Mode] [ECP and EPP 1.7 Mode]

## 2.6.8 APM Configuration

### ErP Ready [Disabled]

Allows BIOS to switch off some power at S5 to get the system ready for ErP requirement. When set to [Enabled], all other PME options will be switched off. Configuration options: [Enabled] [Disabled]

### Deep S4 [Disabled]

Allows you to enable or disable entering deep S4 sleep mode. The system in deep S4 state can be woken up via power button. Configuration options: [Enabled] [Disabled]

### Restore AC Power Loss [Power Off]

- [Power On] The system goes into on state after an AC power loss.
- [Power Off] The system goes into off state after an AC power loss.
- [Last State] The system goes into either off or on state, whatever the system state was before the AC power loss.

### Power On By PS/2 Keyboard [Disabled]

- [Disabled] Disables the Power On by a PS/2 keyboard.
- [Space Bar] Sets the Space Bar on the PS/2 keyboard to turn on the system.
- [Ctrl-Esc] Sets the Ctrl+Esc key on the PS/2 keyboard to turn on the system.
- [Power Key] Sets Power key on the PS/2 keyboard to turn on the system. This feature requires an ATX power supply that provides at least 1A on the +5VSB lead.

### Power On By PCI-E/PCI [Disabled]

This item allows you to enable or disable the Wake-on-LAN function of the onboard LAN controller or other installed PCI-E/PCI LAN cards. Configuration options: [Disabled] [Enabled]

### Power On By Ring [Disabled]

- [Disabled] Disables Ring to generate a wake event.
- [Enabled] Enables Ring to generate a wake event.

### Power On By RTC [Disabled]

- [Disabled] Disables RTC to generate a wake event.
- [Enabled] When set to [Enabled], the items **RTC Alarm Date (Days)** and **Hour/Minute/Second** will become user-configurable with set values.

## 2.6.9 Network Stack Configuration

### Network Stack [Disabled]

This item allows user to disable or enable the UEFI network stack. Configuration options: [Disabled] [Enabled]



---

The following two items appear only when you set the previous item to [Enabled].

---

### Intel(R) Rapid Storage Technology

The subitems in this menu allow the user to manage RAID volumes on the Intel RAID controller.



## 2.7 Monitor menu

The Monitor menu displays the system temperature/power status, and allows you to change the fan settings.

Scroll down to display the other BIOS items.

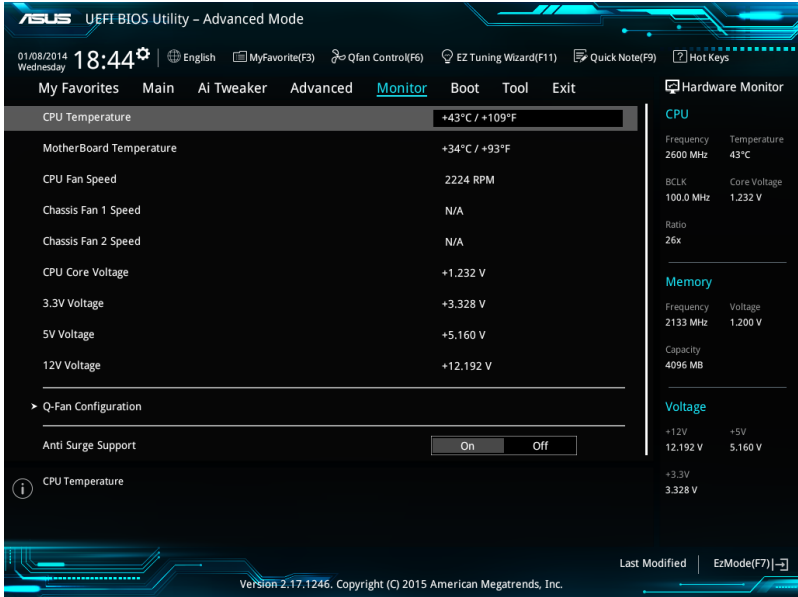

### 2.7.1 CPU/ MB Temperature [xxx°C/xxx°F]/ [Ignore]

The onboard hardware monitor automatically detects and displays the CPU and motherboard temperatures. Select **[Ignore]** if you do not wish to display the detected temperatures.

### 2.7.2 CPU Fan/ Chassis Fan 1/2 Speed [xxxx RPM]/ [Ignore]/ [N/A]

The onboard hardware monitor automatically detects and displays the CPU and chassis fan 1/2 speeds in rotations per minute (RPM). If the fan is not connected to the motherboard, the field shows N/A. Select **[Ignore]** if you do not wish to display the detected speed.

### 2.7.3 CPU Input Voltage (VCCIN), CPU Core Voltage, 3.3V Voltage, 5V Voltage, 12V Voltage

The onboard hardware monitor automatically detects the voltage output through the onboard voltage regulators. Select **[Ignore]** if you do not want to detect this item.

## 2.7.4 Q-Fan Configuration

### Ofan Tuning

Click this item to automatically detect the lowest speed and configure the minimum duty cycle for each fan.

#### CPU Q-Fan Control [Auto]

- [Auto] Detects the type of CPU fan installed and automatically switches the mode control.
- [Disabled] Disables the Q-Fan control.
- [DC Mode] Enables the CPU Q-Fan control feature in DC mode for 3-pin CPU fan.
- [PWM Mode] Enables the CPU Q-Fan control feature in PWM mode for 4-pin CPU fan.

#### CPU Fan Speed Lower Limit [200 RPM]

This item appears only when you enable the CPU Q-Fan Control feature and allows you to disable or set the CPU fan warning speed. Configuration options: [Ignore] [100RPM] [200RPM] [300 RPM] [400 RPM] [500 RPM]

#### CPU Fan Profile [Standard]

This item appears only when you enable the CPU Q-Fan Control feature and allows you to set the appropriate performance level of the CPU fan.

- [Standard] Sets to [Standard] to make the CPU fan automatically adjust depending on the CPU temperature.
- [Silent] Sets to [Silent] to minimize the fan speed for quiet CPU fan operation.
- [Turbo] Sets to [Turbo] to achieve maximum CPU fan speed.
- [Manual] Sets to [Manual] to assign detailed fan speed control parameters.



---

The following four items appear only when you set **CPU Fan Profile** to [Manual].

---

#### CPU Upper Temperature [70]

Use the <+> and <-> keys to adjust the upper limit of the CPU temperature. The values range from 25°C to 75°C.

#### CPU Fan Max. Duty Cycle(%) [100]

Use the <+> and <-> keys to adjust the maximum CPU fan duty cycle. The values range from 20% to 100%. When the CPU temperature reaches the upper limit, the CPU fan will operate at the maximum duty cycle.

#### CPU Middle Temperature [25]

Use the <+> or <-> keys to set the value for CPU Middle Temperature. The range of the values depends on the CPU installed.

#### CPU Fan Middle Duty Cycle(%) [20]

Use the <+> or <-> keys to adjust the CPU fan middle duty cycle. The values range from 20% to 100%. When the CPU temperature reaches the upper limit, the CPU fan operates at the maximum duty cycle.

#### CPU Lower Temperature [20]

Use the <+> or <-> keys to adjust the CPU fan's lower temperature. The values range from 20°C to 75°C.

### **CPU Fan Min. Duty Cycle(%) [20]**

Use the <+> and <-> keys to adjust the minimum CPU fan duty cycle. The values range from 20% to 100%. When the CPU temperature is under the lower limit, the CPU fan will operate at the minimum duty cycle.

## **2.7.5 Chassis Fan 1/2 Q-Fan Control [DC Mode]**

- [PWM mode] Enables the chassis Q-Fan control in PWM mode for 4-pin chassis fan.
- [DC mode] Enables the chassis Q-Fan control in DC mode for 3-pin chassis fan.
- [Disabled] Disables the chassis Q-Fan control feature.



---

The following items appear only when you set the Chassis Fan 1/2 Q-Fan Control to **[PWM Mode]** or **[DC Mode]**.

---

### **Chassis Fan 1/2 Q-Fan Source [CPU]**

This item controls the assigned fan according to the selected temperature source.  
Configuration options: [CPU] [MB]

### **Chassis Fan 1/2 Speed Low Limit [600 RPM]**

This item allows you to disable or set the chassis fan warning speed. Configuration options: [Ignore] [200RPM] [300 RPM] [400 RPM] [500 RPM] [600 RPM]

### **Chassis Fan 1/2 Profile [Standard]**

This item allows you to set the appropriate performance level of the chassis fan.

- [Standard] Sets to [Standard] to make the chassis fan automatically adjust depending on the chassis temperature.
- [Silent] Sets to [Silent] to minimize the fan speed for quiet chassis fan operation.
- [Turbo] Sets to [Turbo] to achieve maximum chassis fan speed.
- [Manual] Sets to [Manual] to assign detailed fan speed control parameters.



---

The following four items appear only when you set **Chassis Fan 1/2 Profile** to [Manual].

---

### **Chassis Fan 1/2 Upper Temperature [70]**

Use the <+> or <-> keys to adjust the upper limit of the CPU temperature. The values range from 40°C to 75°C.

### **Chassis Fan 1/2 Max. Duty Cycle(%) [100]**

Use the <+> or <-> keys to adjust the maximum chassis fan duty cycle. The values range from 60% to 100%. When the chassis temperature reaches the upper limit, the chassis fan will operate at the maximum duty cycle.

### **Chassis Fan 1/2 Middle Temperature [45]**

Use the <+> or <-> keys to set the value for Chassis Fan Middle Temperature.

### **Chassis Fan 1/2 Middle Duty Cycle(%) [60]**

Use the <+> or <-> keys to adjust the chassis fan middle duty cycle. The values range from 60% to 100%.

**Chassis Fan 1/2 Lower Temperature [40]**

Use the <+> or <-> keys to adjust the chassis fans' lower temperature. The values range from 40°C to 75°C.

**Chassis Fan 1/2 Min. Duty Cycle(%) [60]**

Use the <+> or <-> keys to adjust the minimum chassis fan duty cycle. The values range from 60% to 100%. When the CPU temperature is under the lower limit, the chassis fan operates at the minimum duty cycle.

## 2.7.6 Anti Surge Support [On]

This item allows you to enable or disable the Anti Surge function.

Configuration options: [On] [Off]

## 2.8 Boot menu

The Boot menu items allow you to change the system boot options. Scroll down to display the other BIOS items.

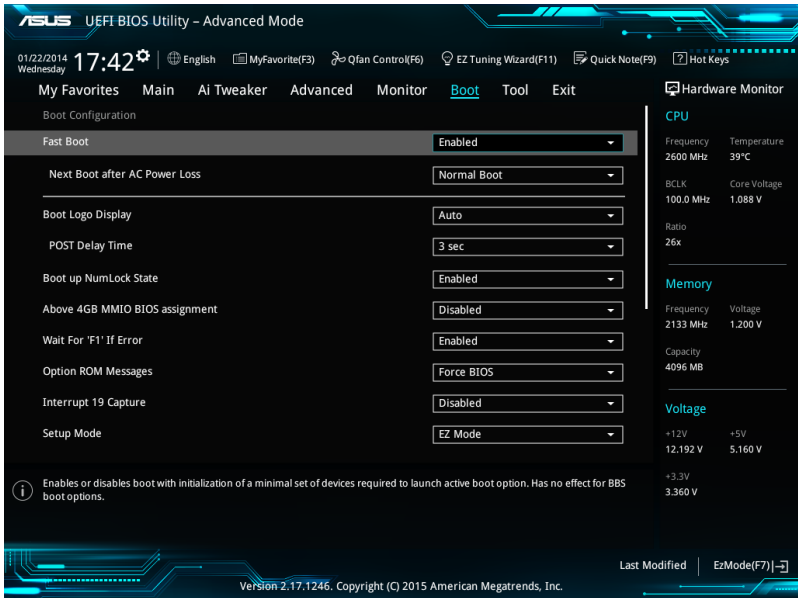

### 2.8.1 Fast Boot [Enabled]

- [Enabled] Select to accelerate the boot speed.
- [Disabled] Select to go back to normal boot speed.

### Next Boot after AC Power Loss [Normal Boot]

This item appears only when **Fast Boot** is set to [Enabled].

- [Normal Boot] Returns to normal boot on the next boot after AC power loss.
- [Fast Boot] Accelerates the boot speed on the next boot after AC power loss.

### 2.8.2 Boot Logo Display [Auto]

- [Auto] Adjusts logo automatically based on Windows® display requirements.
- [Full Screen] Maximize the boot logo size.
- [Disabled] Hide the logo during POST.

## POST Delay Time [3 sec]

This item appears only when you set Boot Logo Display to [Auto] and [Full Screen]. This item allows you to select the desired additional POST waiting time to easily enter the BIOS setup. You can only execute the POST delay time during Normal Boot. The values range from 0 to 10 seconds.



---

This feature will only work under normal boot.

---

## 2.8.3 Bootup NumLock State [Enabled]

This item allows you to enable or disable power-on state of the NumLock. Configuration options: [Disabled] [Enabled]

## 2.8.4 Above 4GB MMIO BIOS assignment [Disabled]

This item allows you to enable/disable above 4G memory mapped IO BIOS assignment. By default this item is set to [Disabled] when Aperture Size is set to 2048 MB. Configuration options: [Disabled] [Enabled]

## 2.8.5 Wait for 'F1' If Error [Enabled]

When this item is set to [Enabled], the system waits for the F1 key to be pressed when error occurs. Configuration options: [Disabled] [Enabled]

## 2.8.6 Option ROM Messages [Force BIOS]

[Force BIOS] The Option ROM Messages will be shown during the POST.

[Keep Current] Only the ASUS logo will be shown during the POST.

## 2.8.7 Interrupt 19 Capture [Disabled]

[Enabled] Allows the option ROMs to trap Interrupt 19.

[Disabled] Disables this function.

## 2.8.8 Setup Mode [EZ Mode]

[Advanced Mode] This item allows you to go to Advanced Mode of the BIOS after POST.

[EZ Mode] This item allows you to go to EZ Mode of the BIOS after POST.

## 2.8.9 CSM (Compatibility Support Module)

Allows you to configure the CSM (Compatibility Support Module) items to fully support the various VGA, bootable devices, and add-on devices for better compatibility.

### Launch CSM [Enabled]

- [Auto] The system automatically detects the bootable devices and the add-on devices.
- [Enabled] For better compatibility, enable the CSM to fully support the non-UEFI driver add-on devices or the Windows® UEFI mode.
- [Disabled] Disable the CSM to fully support the Windows® Security Update and Security Boot.



---

The following four items appear when you set Launch CSM to [Enabled].

---

### Boot Device Control [UEFI and Legacy OPROM]

Allows you to select the type of devices that you want to boot up. Configuration options: [UEFI and Legacy OPROM] [Legacy OPROM only] [UEFI only]

### Boot from Network Devices [Legacy Only]

Allows you to select the type of network devices that you want to launch. Configuration options: [Legacy Only] [UEFI driver first] [Ignore]

### Boot from Storage Devices [Legacy Only]

Allows you to select the type of storage devices that you want to launch. Configuration options: [Legacy nly] [UEFI driver first] [Ignore]

### Boot from PCI-E Expansion Devices [Legacy Only]

Allows you to select the type of PCI-E expansion devices that you want to launch. Configuration options: [Legacy Only] [UEFI driver first]

## 2.8.10 Secure Boot

Allows you to configure the Windows® Secure Boot settings and manage its keys to protect the system from unauthorized access and malwares during POST.

### OS Type [Windows UEFI mode]

Allows you to select your installed operating system.

- [Windows UEFI mode] This item allows you to select your installed operating system. Execute the Microsoft® Secure Boot check. Only select this option when booting on Windows® UEFI mode or other Microsoft® Secure Boot compliant OS.
- [Other OS] Get the optimized function when booting on Windows® non-UEFI mode. Microsoft® Secure Boot only supports Windows® UEFI mode.

### Key Management

This allows you to manage the Secure Boot keys.

### Install Default Secure Boot keys

This item allows you to immediately load the default Security Boot keys, Platform key (PK), Key-exchange Key (KEK), Signature database (db), and Revoked Signatures (dbx). When the default Secure boot keys are loaded, all the Secure Boot keys' state will change from Unloaded mode to loaded mode.

### Clear Secure Boot keys

This item appears only when you load the default Secure Boot keys. This item allows you to clear all the previously applied Secure Boot keys.

### Save Secure Boot Keys

This item allows you to save all the Secure Boot keys to a USB storage device.

### PK Management

The Platform Key (PK) locks and secures the firmware from any non-permissible changes. The system verifies the PK before your system enters the OS.

#### **Set New Key**

This item allows you to load the downloaded PK from a USB storage device.



---

The PK file must be formatted as a UEFI variable structure with time-based authenticated variable.

---

#### **Delete Key**

This item allows you to delete the PK from your system. Once the PK is deleted, all the system's Secure Boot keys will not be active.

Configuration options: [Yes] [No]

### KEK Management

The KEK (Key-exchange Key or Key Enrollment Key) manages the Signature database (db) and Revoked Signature database (dbx).



---

Key-exchange Key (KEK) refers to Microsoft® Secure Boot Key-Enrollment Key (KEK).

---

#### **Set New Key**

Allows you to load the downloaded KEK from a USB storage device.

#### **Append Key**

Allows you to load the additional KEK from a storage device for an additional db and dbx loaded management.

#### **Delete Key**

Allows you to delete the KEK from your system. Configuration options: [Yes] [No]



---

The KEK file must be formatted as a UEFI variable structure with time-based authenticated variable.

---

### DB Management

The db (Authorized Signature database) lists the signers or images of UEFI applications, operating system loaders, and UEFI drivers that you can load on the single computer.



**Set New Key**

Allows you to load the downloaded db from a USB storage device.

**Append Key**

Allows you to load the additional db from a storage device so that more images can be loaded securely.

**Delete Key**

Allows you to delete the db file from your system.

Configuration options: [Yes] [No]



- The DB file must be formatted as a UEFI variable structure with time-based authenticated variable.
- UEFI executable files include UEFI boot devices, drivers and applications.

**dbx Management**

The dbx (Revoked Signature database) lists the forbidden images of db items that are no longer trusted and cannot be loaded.

**Set New Key**

Allows you to load the downloaded dbx from a USB storage device.

Configuration options: [Yes] [No]

**Append Key**

Allows you to load the additional dbx from a storage device so that more db's images cannot be loaded.

**Delete Key**

Allows you to delete the dbx file from your system.



The DBX file must be formatted as a UEFI variable structure with time-based authenticated variable.

**2.8.11 Boot Option Priorities**

These items specify the boot device priority sequence from the available devices. The number of device items that appears on the screen depends on the number of devices installed in the system.



- To access Windows® OS in Safe Mode, press <F8 > after POST (Windows® 8 not supported).
- To select the boot device during system startup, press <F8> when ASUS Logo appears.

**2.8.12 Boot Override**

These items displays the available devices. The number of device items that appears on the screen depends on the number of devices installed in the system. Click an item to start booting from the selected device.

## 2.9 Tool menu

The Tool menu items allow you to configure options for special functions. Select an item then press <Enter> to display the submenu.

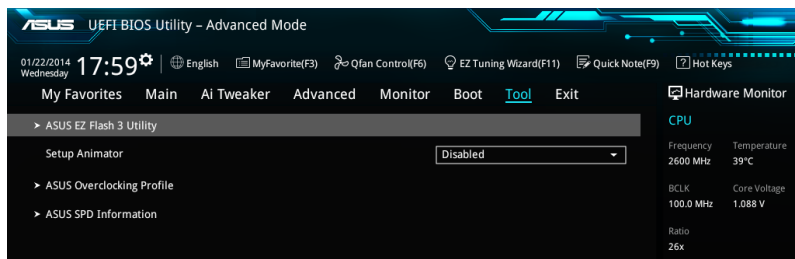

### 2.9.1 ASUS EZ Flash 3 Utility

Allows you to run ASUS EZ Flash 3. Press [Enter] to launch the ASUS EZ Flash 3 screen.



---

For more details, see section 2.1.2 **ASUS EZ Flash 3**.

---

### 2.9.2 Setup Animator [Disabled]

Enables or disables the Setup animator. Configuration options: [Disabled] [Enabled]

### 2.9.3 ASUS Overclocking Profile

This item allows you to store or load multiple BIOS settings.



---

The **Overclocking Profile** items show **Not assigned** if no profile is created.

---

#### Load from Profile

Allows you to load the previous BIOS settings saved in the BIOS Flash. Key in the profile number that saved your CMOS settings, press <Enter>, and then select Yes.



- DO NOT shut down or reset the system while updating the BIOS to prevent the system boot failure!
  - We recommend that you update the BIOS file only coming from the same memory/CPU configuration and BIOS version.
- 

#### Profile Name

Allows you to create a name for the profile you want to save.

#### Save to Profile

Allows you to save the current BIOS settings to the BIOS Flash, and create a profile. Key in a profile number from one to eight, press <Enter>, and then select Yes.

## Load/Save Profile from/to USB Drive

This item allows you to load or save profile from your USB drive, load and save profile to your USB drive.

## 2.9.4 ASUS SPD Information

### DIMM Slot number [DIMM\_A1]

Displays the Serial Presence Detect (SPD) information of the DIMM module installed on the selected slot. Configuration options: [DIMM\_A1] [DIMM\_B1] [DIMM\_A2] [DIMM\_B2]

## 2.10 Exit menu

The Exit menu items allow you to load the optimal default values for the BIOS items, and save or discard your changes to the BIOS items.

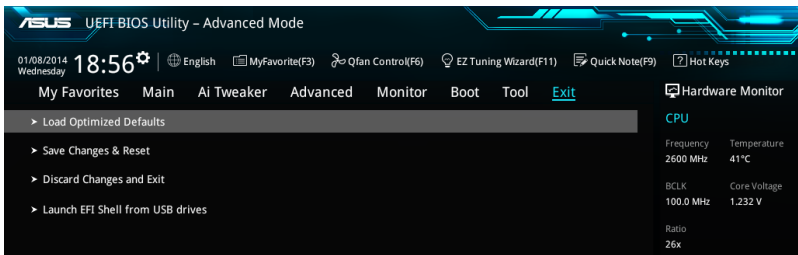

### Load Optimized Defaults

This option allows you to load the default values for each of the parameters on the Setup menus. When you select this option or if you press <F5>, a confirmation window appears. Select OK to load the default values.

### Save Changes & Reset

Once you are finished making your selections, choose this option from the Exit menu to ensure the values you selected are saved. When you select this option or if you press <F10>, a confirmation window appears. Select OK to save changes and exit.

### Discard Changes & Exit

This option allows you to exit the Setup program without saving your changes. When you select this option or if you press <Esc>, a confirmation window appears. Select OK to discard changes and exit.

### Launch EFI Shell from USB drives

This option allows you to attempt to launch the EFI Shell application (shellx64.efi) from one of the available USB devices.



# Appendices

## Notices

### Federal Communications Commission Statement

This device complies with Part 15 of the FCC Rules. Operation is subject to the following two conditions:

- This device may not cause harmful interference.
- This device must accept any interference received including interference that may cause undesired operation.

This equipment has been tested and found to comply with the limits for a Class B digital device, pursuant to Part 15 of the FCC Rules. These limits are designed to provide reasonable protection against harmful interference in a residential installation. This equipment generates, uses and can radiate radio frequency energy and, if not installed and used in accordance with manufacturer's instructions, may cause harmful interference to radio communications. However, there is no guarantee that interference will not occur in a particular installation. If this equipment does cause harmful interference to radio or television reception, which can be determined by turning the equipment off and on, the user is encouraged to try to correct the interference by one or more of the following measures:

- Reorient or relocate the receiving antenna.
- Increase the separation between the equipment and receiver.
- Connect the equipment to an outlet on a circuit different from that to which the receiver is connected.
- Consult the dealer or an experienced radio/TV technician for help.



---

The use of shielded cables for connection of the monitor to the graphics card is required to assure compliance with FCC regulations. Changes or modifications to this unit not expressly approved by the party responsible for compliance could void the user's authority to operate this equipment.

---

### IC: Canadian Compliance Statement

Complies with the Canadian ICES-003 Class B specifications. This device complies with RSS 210 of Industry Canada. This Class B device meets all the requirements of the Canadian interference-causing equipment regulations.

This device complies with Industry Canada license exempt RSS standard(s). Operation is subject to the following two conditions: (1) this device may not cause interference, and (2) this device must accept any interference, including interference that may cause undesired operation of the device.

Cet appareil numérique de la Classe B est conforme à la norme NMB-003 du Canada.

Cet appareil numérique de la Classe B respecte toutes les exigences du Règlement sur le matériel brouilleur du Canada.

Cet appareil est conforme aux normes CNR exemptes de licence d'Industrie Canada. Le fonctionnement est soumis aux deux conditions suivantes :

- (1) cet appareil ne doit pas provoquer d'interférences et
- (2) cet appareil doit accepter toute interférence, y compris celles susceptibles de provoquer un fonctionnement non souhaité de l'appareil.

## Canadian Department of Communications Statement

This digital apparatus does not exceed the Class B limits for radio noise emissions from digital apparatus set out in the Radio Interference Regulations of the Canadian Department of Communications.

This class B digital apparatus complies with Canadian ICES-003.

## VCCI: Japan Compliance Statement

### VCCI Class B Statement

この装置は、クラスB 情報技術装置です。この装置は、家庭環境で使用することを目的としていますが、この装置がラジオやテレビジョン受信機に近接して使用されると、受信障害を引き起こすことがあります。

取扱説明書に従って正しい取り扱いをして下さい。

V C C I - B

This is a Class B product based on the standard of the VCCI Council. If this is used near a radio or television receiver in a domestic environment, it may cause radio interference. Install and use the equipment according to the instruction manual.

## KC: Korea Warning Statement

B급 기기 (가정용 방송통신기자재)

이 기기는 가정용(B급) 전자파적합기기로서 주로 가정에서 사용하는 것을 목적으로 하며, 모든 지역에서 사용할 수 있습니다.

\*당해 무선설비는 전파혼신 가능성이 있으므로 인명안전과 관련된 서비스는 할 수 없습니다.

## REACH

Complying with the REACH (Registration, Evaluation, Authorisation, and Restriction of Chemicals) regulatory framework, we published the chemical substances in our products at ASUS REACH website at <http://csr.asus.com/english/REACH.htm>.



DO NOT throw the motherboard in municipal waste. This product has been designed to enable proper reuse of parts and recycling. This symbol of the crossed out wheeled bin indicates that the product (electrical and electronic equipment) should not be placed in municipal waste. Check local regulations for disposal of electronic products.



DO NOT throw the mercury-containing button cell battery in municipal waste. This symbol of the crossed out wheeled bin indicates that the battery should not be placed in municipal waste.

## ASUS Recycling/Takeback Services

ASUS recycling and takeback programs come from our commitment to the highest standards for protecting our environment. We believe in providing solutions for you to be able to responsibly recycle our products, batteries, other components as well as the packaging materials. Please go to <http://csr.asus.com/english/Takeback.htm> for detailed recycling information in different regions.

# Google™ License Terms

Copyright© 2014 Google Inc. All Rights Reserved.

Licensed under the Apache License, Version 2.0 (the "License"); you may not use this file except in compliance with the License. You may obtain a copy of the License at:

<http://www.apache.org/licenses/LICENSE-2.0>

Unless required by applicable law or agreed to in writing, software distributed under the License is distributed on an "AS IS" BASIS, WITHOUT WARRANTIES OR CONDITIONS OF ANY KIND, either express or implied.

See the License for the specific language governing permissions and limitations under the License.

**English** AsusTek Inc. hereby declares that this device is in compliance with the essential requirements and other relevant provisions of CE Directives. Please see the CE Declaration of Conformity for more details.

**Français** AsusTek Inc. déclare par la présente que cet appareil est conforme aux critères essentiels et autres clauses pertinentes des directives européennes. Veuillez consulter la déclaration de conformité CE pour plus d'informations.

**Deutsch** AsusTek Inc. erklärt hiermit, dass dieses Gerät mit den wesentlichen Anforderungen und anderen relevanten Bestimmungen der CE-Richtlinien übereinstimmt. Weitere Einzelheiten entnehmen Sie bitte der CE-Konformitätserklärung.

**Italiano** AsusTek Inc. con la presente dichiara che questo dispositivo è conforme ai requisiti essenziali e alle altre disposizioni pertinenti alle direttive CE. Per maggiori informazioni fate riferimento alla dichiarazione di conformità CE.

**Компания** ASUS заявляет, что это устройство соответствует основным требованиям и другим соответствующим условиям европейских директив. Подробную информацию, пожалуйста, смотрите в декларации соответствия.

**Български** С настоящото AsusTek Inc. декларира, че това устройство е в съответствие със съществениите изисквания и другите приложения на директивите СЕ. Вижте СЕ декларацията за съвместимост за повече информация.

**Hrvatski** AsusTek Inc. ovim izjaviuje da je ovaj uređaj skladan s bitnim zahtjevima i ostalim odgovarajućim odredbama CE direktiva. Više pojedinosti potražite u CE izjavi o skladnosti.

**Čeština** Společnost AsusTek Inc. tímto prohlašuje, že toto zařízení splňuje základní požadavky a další příslušná ustanovení směrnice CE. Další podrobnosti viz Prohlášení o shodě CE.

**Dansk** AsusTek Inc. Erklærer hermed, at denne enhed er i overensstemmelse med hovedkravene and andre relevante bestemmelser i CE-direktiverne. Du kan læse mere i CE-overensstemmelseserklæring.

**Nederlands** AsusTek Inc. verklaart hierbij dat dit apparaat compatibel is met de essentiële vereisten en andere relevante bepalingen van CE-richtlijnen. Raadpleeg de CE-verklaring van conformiteit voor meer details.

**Eesti** Käesolevaga kinnitab AsusTek Inc., et see seade vastab CE direktiivide olulistele nõuetele ja teistele asjakohastele sätetele. Vt üksikasju CE vastavusdeklaratsioonis.

**Suomi** AsusTek Inc. vakuuttaa täten, että tämä laite on CE-direktiivien olennaisten vaatimusten ja muiden asiaan kuuluvien lisäysten mukainen. Katso lisätietoja CE-vaatimustenmukaisuusvakuutuksesta.

**Ελληνικά** Με το παρόν, η AsusTek Inc. δηλώνει ότι αυτή η συσκευή συμμορφώνεται με τις θεμελιώδεις απαιτήσεις και άλλες σχετικές διατάξεις των Οδηγιών της ΕΕ. Για περισσότερες λεπτομέρειες ανατρέξτε στην Δήλωση Συμμόρφωσης ΕΕ.

**Magyar** Az AsusTek Inc. ezennel kijelenti, hogy a készülék megfelel a CE-irányelvek alapvető követelményeinek és ide vonatkozó egyéb rendelkezéseinek. További részletekért tekintse meg a CE-megfelelőségi nyilatkozatot.

**Latviski** Lidz ar šo AsusTek Inc. paziņo, ka šī ierīce atbilst būtiskajām prasībām un citiem saistošajiem nosacījumiem, kas norādīti CE direktīvā. Lai uzzinātu vairāk, skatiet CE Atbilstības deklarāciju.

**Lietuvyski** Šiuo dokumentu bendrovė „AsusTek Inc.“ pareiškia, kad šis įrenginys atitinka pagrindinius CE direktyvų reikalavimus ir kitas susijusias nuostatas. Daugiau informacijos rasite CE atitikties deklaracijoje.

**Norsk** AsusTek Inc. erklærer herved at denne enheten er i samsvar med hovedsaklige krav og andre relevante forskrifter i CE-direktiver. Du finner mer informasjon i CE-samsvarserklæringen.

**Polski** Niniejszym AsusTek Inc. deklaruje, że urządzenie jest zgodne z istotnymi wymaganiami oraz innymi powiązanymi zaleceniami Dyrektywy CE. W celu uzyskania szczegółów, sprawdź Deklarację zgodności CE.

**Português** A AsusTek Inc. declara que este dispositivo está em conformidade com os requisitos essenciais e outras disposições relevantes das Diretivas da CE. Para mais detalhes, consulte a Declaração de Conformidade CE.

**Română** Prin prezenta, AsusTek Inc. declară faptul că acest dispozitiv respectă cerințele esențiale și alte prevederi relevante ale directivelor CE. Pentru mai multe detalii, consultați declarația de conformitate CE.

**Srpski** AsusTek Inc. ovim izjaviuje da je ovaj uređaj u saglasnosti sa ključnim zahtjevima i drugim relevantnim odredbama CE Direktiva. Molimo vas, pogledajte CE Deklaraciju u skladnosti za više detalja.

**Slovensky** Spoločnosť AsusTek Inc. týmto prehlasuje, že toto zariadenie vyhovuje príslušným požiadavkám a ďalším súvisiacim ustanoveniam smernice ES. Viac podrobností si pozrite v prehlásení o zhode ES.

**Slovenščina** AsusTek Inc. tukaj izjavlja, da je ta naprava skladna s temeljnimi zahtevami in drugimi relevantnimi določili direktiv CE. Za več informacij glejte izjavo CE o skladnosti.

**Español** Por la presente, AsusTek Inc. declara que este dispositivo cumple los requisitos básicos y otras disposiciones relevantes de las directivas de la CE. Consulte la Declaración de conformidad de la CE para obtener más detalles.

**Svenska** AsusTek Inc. förklarar härmed att denna enhet är i överensstämmelse med de grundläggande kraven och andra relevanta bestämmelser i CE-direktiv. Se CE-försäkran om överensstämmelse för mer information.

**Українська** AsusTek Inc. заявляє, що цей пристрій відповідає основним вимогам відповідних Директив ЄС. Будь ласка, див. більше подробиць у Декларації відповідності нормам ЄС.

**Türkçe** AsusTek Inc., bu aygıtın temel gereksinimlerle ve CE Yönergelerinin diğer ilgili koşullarıyla uyumlu olduğunu beyan eder. Daha fazla ayrıntı için lütfen CE Uygunluk Beyanına bakın.

**Bosanski** AsusTek Inc. ovim potvrđuje da je ovaj uređaj uskladen s osnovnim zahtjevima i drugim relevantnim propisima Direktiva EK. Za više informacija molimo pogledajte Deklaraciju u skladnosti EK.

## ASUS contact information

### ASUSTeK COMPUTER INC.

Address 15 Li-Te Road, Peitou, Taipei, Taiwan 11259  
Telephone +886-2-2894-3447  
Fax +886-2-2890-7798  
E-mail [info@asus.com.tw](mailto:info@asus.com.tw)  
Web site <http://www.asus.com>

#### **Technical Support**

Telephone +86-21-3842-9911  
Fax +86-21-5866-8722 ext. 9101#  
Online support <http://support.asus.com/techserv/techserv.aspx>

### ASUS COMPUTER INTERNATIONAL (America)

Address 800 Corporate Way, Fremont, CA 94539, USA  
Telephone +1-510-739-3777  
Fax +1-510-608-4555  
Web site <http://www.asus.com/us/>

#### **Technical Support**

Support fax +1-812-284-0883  
General support +1-812-282-2787  
Online support <http://www.service.asus.com/>

### ASUS COMPUTER GmbH (Germany and Austria)

Address Harkort Str. 21-23, D-40880 Ratingen, Germany  
Fax +49-2102-959931  
Web site <http://www.asus.com/de>  
Online contact <http://eu-rma.asus.com/sales>

#### **Technical Support**

Telephone +49-2102-5789555  
Support Fax +49-2102-959911  
Online support <http://www.asus.com/de/support/>



# DECLARATION OF CONFORMITY

Per FCC Part 2, Section 2.1077(a)



Responsible Party Name: **Asus Computer International**

Address: **800 Corporate Way, Fremont, CA 94539,**

Phone/Fax No: **(510)739-3777/(510)608-4555**

hereby declares that the product

**Product Name : Motherboard**

**Model Number : Z170M-PLUS**

Conforms to the following specifications:

FCC Part 15, Subpart B, Unintentional Radiators

### Supplementary Information:

This device complies with part 15 of the FCC Rules. Operation is subject to the following two conditions: (1) This device may not cause harmful interference, and (2) this device must accept any interference received, including interference that may cause undesired operation.

Representative Person's Name : Steve Chang / President

Signature :

Date : Jun. 26, 2015

Ver: 146033



# EC Declaration of Conformity

We, the undersigned,

Manufacturer: **ASUS (K) COMPUTER INC.**  
4F, No. 150, LI TE RD., PEITOU, TAIPEI 112, TAIWAN  
Authorized representative in Europe: **ASUS COMPUTER GmbH**  
Address, City: **HARKORT STR. 21-23, 40880 RATINGEN**  
Country: **GERMANY**

declare the following apparatus:

Product name : **Motherboard**  
Model name : **Z170M-PLUS**

conform with the essential requirements of the following directives:

### 2004/109/EC-EMC Directive

EN 55022:2013/AM2:2017:009  
 EN 55024:2010:008  
 EN 55020:2007/A1:1:2011

### 1989/532/EEC-RATE Directive

EN 300 328 V1.8.1 (2012-06)  
 EN 300 443 V1.5.1 (2010-08)  
 EN 300 342 V1.5.1 (2010-08)  
 EN 301 511 V9.0.2 (2010-03)  
 EN 301 908 V1 V6.2.1 (2011-05)  
 EN 301 883 V1.7.1 (2012-06)  
 EN 302 542 V1.1.1 (2009-01)  
 EN 302 542 V1.1.1 (2009-01)  
 EN 300 600:2001  
 EN 60979-2010  
 EN 62311:2008

### 2006/95/EC-LVD Directive

EN 60950-1:2006 /A12: 2011  
 EN 60950-1:2006 /A2: 2013

### 2009/123/EC-EP Directive

Regulation (EC) No. 1275/2008  
 Regulation (EC) No. 642/2009

### 2011/65/EU-REHS Directive

### CE marking



(EC conformity marking)

Position : **CEO**  
Name : **Jerry Shen**

Declaration Date: **26/06/2015**

Year to begin affixing CE marking: **2015**

Signature : \_\_\_\_\_

Ver: 15026