

FR Guide de l'utilisateur
EN User's guide
DE Bedienungsanleitung
NL Gebruiksaanwijzing
ES Guía del usuario
PT Guia del usuario
IT Manuale d'uso
DA Brugsvejledning
NO Bruksanvisning
SV Användarhandbok
FI Käyttöopas
TR Kullanım kılavuzu
EL Οδηγός χρήσης
PL Instrukcja obsługi
CS Návod k použití
SK Používateľská príručka

HU Használati útmutató
SL Navodila za uporabnika
RU Руководство пользователя
UK Посібник користувача
HR Upute za uporabu
RO Ghidul utilizatorului
ET Kasutusjuhend
LT Naudotojo vadovas
LV Lietošanas pamācība
BG Ръководство на потребителя
SR Korisničko uputstvo
BS Korisnički priručnik
AR دليل الإستعمال
TH คู่มือสำหรับผู้ใช้งาน
ZH 使用指南



Purely & Simply

FR Pour plus d'informations sur l'utilisation / **EN** For further usage information / **DE** Weitere Informationen zur Bedienung / **NL** Voor meer informatie over het gebruik / **ES** Para obtener más información sobre su uso / **PT** Para obter mais informações sobre a utilização / **IT** Per maggiori informazioni sull'utilizzo / **DA** Yderligere informationer vedrørende betjening / **NO** For mer informasjon om bruken / **SV** För mer information om användningen / **FI** Lisätietoä käyttöä varten / **TR** Kullanım hakkında daha fazla bilgi için / **EL** Για περισσότερες πληροφορίες σχετικά με τη χρήση / **PL** Więcej informacji na temat korzystania z urządzenia / **CS** Pro více informací o použití / **SK** Pre ďalšie informácie o používaní / **HU** A használatra vonatkozó további információk / **SL** Več informacij o uporabi / **RU** Для получения более подробной информации об эксплуатации / **UK** Для отримання детальнішої інформації щодо експлуатації / **HR** Za više informacija o upotrebi / **RO** Pentru mai multe informații privind utilizarea / **ET** Täiendava teabe saamiseks kasutamise kohta / **LT** Daugiau informacijos apie naudojimą / **LV** Lai iegūtu vairāk informācijas par lietošanu / **BG** За още информация относно употребата / **BS** Za više informacija o upotrebi / **SR** Za više informacija o upotrebi / **AR** للمزيد من المعلومات عن الإستعمال / **TH** สำหรับข้อมูลเพิ่มเติมเกี่ยวกับการใช้งาน / **ZH** 更多关于使用的信息:



www.tefal.com - www.calor.fr - www.moulinex.com



FR Veuillez lire attentivement le livret "Consignes de sécurité et d'utilisation" avant la première utilisation / **EN** Please read carefully the "Safety and use instructions" booklet before first use / **DE** Lesen Sie vor dem erstmaligen Gebrauch aufmerksam die Broschüre „Sicherheits- und Bedienungshinweise“ durch. / **NL** Gelieve vóór het eerste gebruik aandachtig het boekje met de veiligheids- en gebruiksvorschriften door te nemen / **ES** Lea detenidamente el libro «Instrucciones de seguridad y de uso» antes de utilizar el aparato por primera vez / **PT** Leia atentamente o manual «Instruções de segurança e utilização» antes da primeira utilização / **IT** Leggere con attenzione il libretto "Norme di sicurezza e d'uso" al primo utilizzo / **DA** Læs hæftet "Sikkerheds- og brugsanvisning" grundigt igennem inden den første ibrugtagning. / **NO** Les nøye heftet "Råd om sikkerhet og bruk" før første gangs bruk / **SV** Var god läs häftet "Säkerhets- och användningsinstruktioner" innan den första användningen. / **FI** Lue turvallisuu- ja käyttöohjevihko huolellisesti ennen ensimmäistä käyttökertaa. / **TR** İlk kullanımdan önce "Güvenlik ve kullanım talimatları" kitapçığını dikkatlice okuyun / **EL** Διαβάστε προσεκτικά το εγχειρίδιο «Οδηγίες ασφαλείας και χρήσης» πριν από την πρώτη χρήση / **PL** Przed pierwszym użyciem proszę uważnie przeczytać broszurę „Zalecenia dotyczące bezpieczeństwa i użytkowania” / **CS** Před prvním použitím si, prosím, pečlivě prostudujte „Bezpečnostní pokyny pro použití” / **SK** Pred prvým použitím si pozorne prečítajte „Bezpečnostné odporúčania a použitie”. / **HU** Az első használat előtt figyelmesen olvassa el a „Biztonsági előírások és használati útmutató” című fejezetet / **SL** Pred prvo uporabo natančno preberite »Navodila za varno uporabo« / **RU** Перед первым использованием внимательно прочитайте инструкцию «Меры безопасности и правила использования». / **UK** Перед першим використанням уважно прочитайте посібник «Правила техніки безпеки та рекомендації щодо використання» / **HR** Molimo da prije prve uporabe pažljivo pročitate priručnik „Sigurnosne upute” / **RO** Înainte de prima utilizare, citiți cu atenție manualul „Instrucțiunile de siguranță și de utilizare” / **ET** Palun lugege enne esimest korda kasutamist hoolikalt ohutus- ja kasutusjuhendit / **LT** Atidžiai perskaitykite knygelę „Saugos ir naudojimo reikalavimai” prieš naudodami įrenginį pirmą kartą / **LV** Pirms izmantojat ierīci pirmoreiz, lūdzu rūpīgi izlasiet brošūru "Norādījumi par drošību un lietošanu" / **BG** Моля, прочетете внимателно книжката "Препоръки за безопасност и употреба" преди първоначална употреба / **SR** Molimo da pre prve upotrebe pažljivo pročitate knjižicu «Uputstva za bezbednost i upotrebu» / **BS** Molimo da prije prve upotrebe pažljivo pročitate knjižicu «Upute za sigurnost i upotrebu» / **AR** يرجى قراءة كتيب السلامة وإرشادات الإستعمال بعناية قبل الإستعمال للمرة الأولى / **TH** กรุณาอ่านหนังสือคู่มือความปลอดภัยและการใช้งาน" ก่อนการใช้งานครั้งแรก / **ZH** 在第一次使用前请认真阅读此“安全操作规程”手册



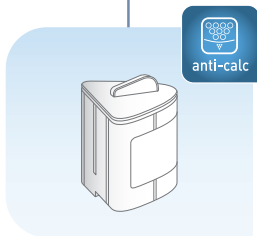
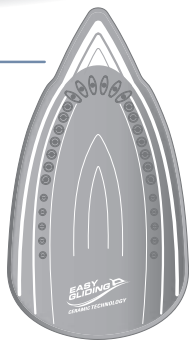
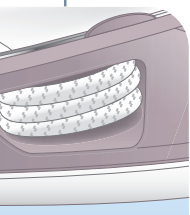
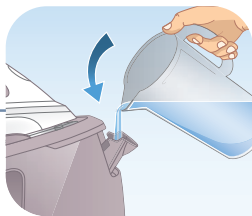
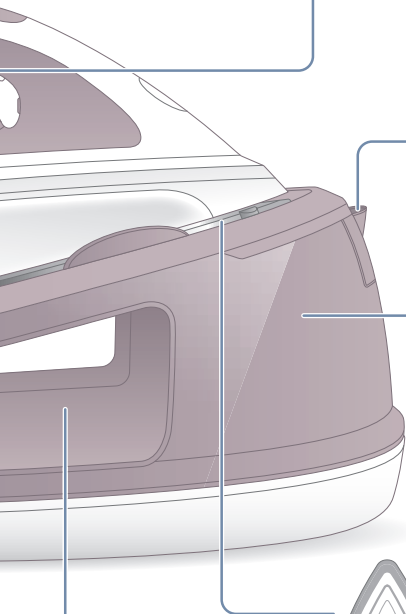
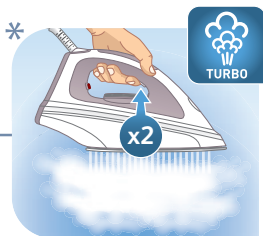
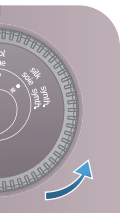

modelo / **PT** Consoante o modelo / **IT**
ouen / **TR** Modele göre / **EL** ανάλογα με
odvisno od modela / **RU** В зависимости
gal modelj / **LV** Atbilstoši modelim / **BG**
H 视型号而定



www.tefal.com - www.calor.fr - www.moulinex.com



1.



www.tefal.com - www.calor.fr - www.moulinex.com

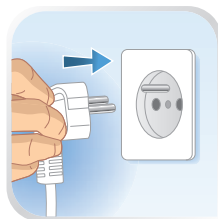
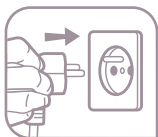

2.



www.tefal.com - www.calor.fr - www.moulinex.com



ON

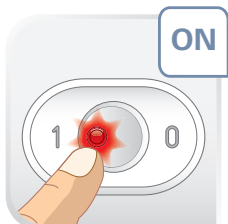

ON

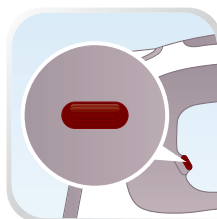
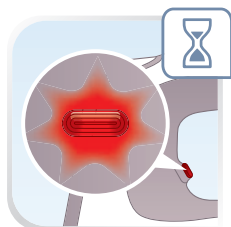
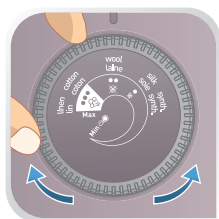
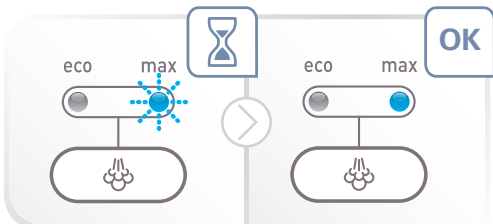

eco

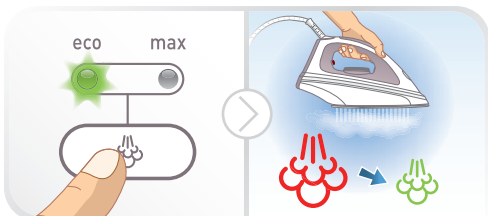
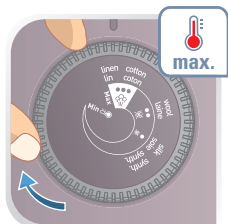

2.



www.tefal.com - www.calor.fr - www.moulinex.com

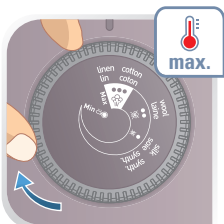

* **FR** Selon modèle / **EN** Depending on model / **DE** Je nach Modell / **NL** Afhankelijk van het model / **ES** Según modelo / **PT** Consoante o modelo / **IT** Secondo i modelli / **DA** Afhængig af model / **NO** Avhenger av modell / **SV** Beroende på modell / **FI** Mallista riippuen / **TR** Modele göre / **EL** ανάλογα με το μοντέλο / **PL** W zależności od typu / **CS** Podle modelu / **SK** V závislosti od modelu / **HU** Modeltől függően / **SL** Odvisno od modela / **RU** В зависимости от модели / **UK** Залежно від моделі / **HR** Ovisno o modelu / **RO** Ovisno o modelu / **ET** Sõltuvalt mudelist / **LT** Pagal modelį / **LV** Atbilstoši modelim / **BG** в зависимост от модела / **SR** U zavisnosti od modela / **BS** Ovisno o modelu / **AR** حسب الموديل / **TH** ตามรุ่น / **ZH** 视型号而定

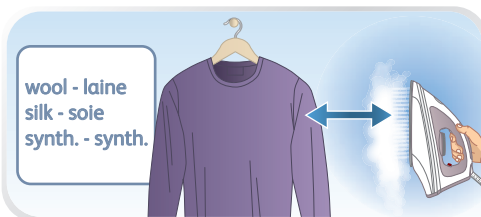
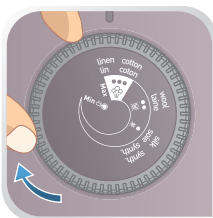

2.



www.tefal.com - www.calor.fr - www.moulinex.com

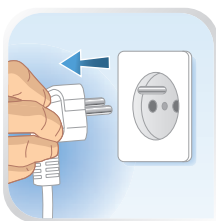
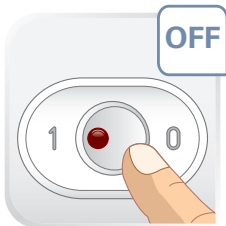

3.



www.tefal.com - www.calor.fr - www.moulinex.com

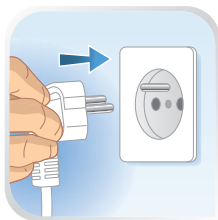
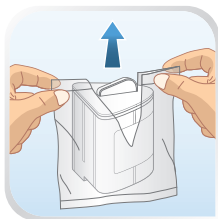
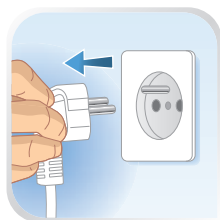
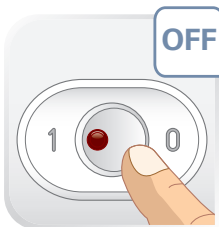
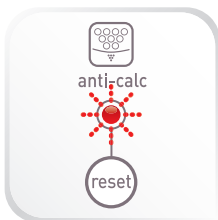

3.



www.tefal.com - www.calor.fr - www.moulinex.com



...

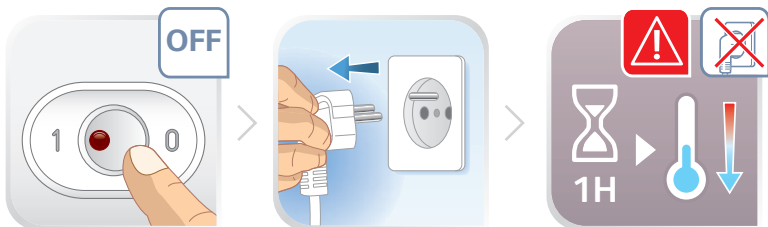
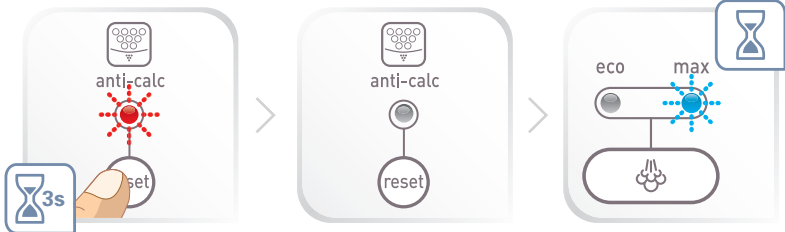

3.



www.tefal.com - www.calor.fr - www.moulinex.com

