



Owner's Manual IPS LED MONITOR (LED MONITOR*)

***LG LED Monitors are LCD Monitors with LED Backlighting.**

Please read the safety information carefully before using the product.

IPS LED Monitor (LED Monitor) Model List

29UM67

29UB67

34UM67

34UB67

CONTENTS

3 LICENSE

4 ASSEMBLING AND PREPARING

- 4 Product Components
- 5 Component and Button Description
- 8 - How to Use the Joystick Button
- 9 Moving and Lifting the Monitor
- 10 Installing the Monitor
- 10 - Assembling the stand base
- 12 - Using the cable holder
- 13 - Installing onto a table
- 14 - Adjusting the stand height
- 15 - Adjusting the angle
- 16 - Pivot feature
- 17 - Using the Kensington lock
- 17 - Installing the wall mount plate
- 18 - Installing to a wall

19 USING THE MONITOR

- 19 Connecting to a PC
- 19 - DVI connection
- 20 - DisplayPort connection
- 20 - HDMI connection
- 21 Connecting to AV Devices
- 21 - HDMI connection
- 22 Connecting to External Devices
- 22 - USB Cable connection - PC
- 22 - Connecting Headphones

23 INSTALLING LG MONITOR SOFTWARE

- 26 Installing The Dual Controller

28 USER SETTINGS

- 29 Customizing settings
- 29 - Menu Settings
- 29 - -Quick Settings
- 30 - -PBP
- 31 - -Picture
- 33 - -Sound
- 34 - -General
- 35 - -Reset
- 36 - -Picture mode

37 TROUBLESHOOTING

39 SPECIFICATIONS

- 39 29UM67
- 40 29UB67
- 41 34UM67
- 42 34UB67
- 43 Factory support mode (DVI-D/ HDMI/ DisplayPort)
- 43 HDMI Timing (Video)
- 43 Indicator

44 PROPER POSTURE

- 44 Proper Posture for Using the Monitor

LICENSE

Each model has different licenses. Visit www.lg.com for more information on the license.



The terms HDMI and HDMI High-Definition Multimedia Interface, and the HDMI logo are trademarks or registered trademarks of HDMI Licensing LLC in the United States and other countries.



VESA, VESA logo, Display Port Compliance Logo and Display Port Compliance Logo for dual-mode source are all registered trademarks of the Video Electronics Standards Association.





The following content is only applied to the monitor which is sold in Europe market and which needs to meet the ErP Directive:

- * This monitor is set to be turned off automatically in 4 hours after you turned on display if there is no adjustment to display.
- * To make this setting be disabled, change the option to 'Off' in OSD menu of "Automatic Standby".

ASSEMBLING AND PREPARING

Product Components

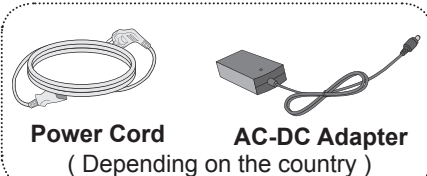
Please check whether all the components are included in the box before using the product. If there are missing components, contact the retail store where you purchased the product. Note that the product and components may look different from those shown here.

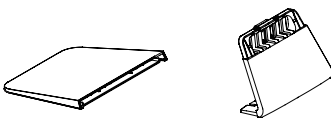
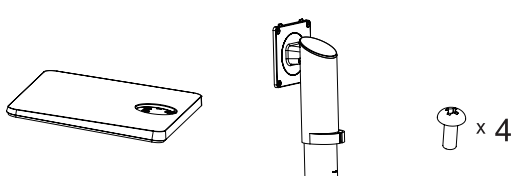
 <p>CD (Owner's Manual) / Card</p>	<p>OPTIONAL ACCESSORIES</p> <div style="display: flex; justify-content: space-around;"> <div data-bbox="397 463 699 734"> <p>Display Port Cable The DisplayPort cable may not be available in some areas.</p> </div> <div data-bbox="713 463 1001 734"> <p>DVI-D Dual Cable (This cable is not included in all countries.)</p> </div> <div data-bbox="1015 463 1262 734"> <p>USB Cable (This cable is not included in all countries.)</p> </div> </div>			
<p>29UB67</p>  <p>Power Cord</p>	<p>29UM67 34UM67 34UB67</p>  <p>Power Cord AC-DC Adapter (Depending on the country)</p>		<p>or</p>  <p>AC-DC Adapter HDMI Cable (Depending on the country) (This cable is not included in all countries.)</p>	
<p>29UM67 34UM67</p>  <p>Stand Base Stand Body</p>		<p>29UB67 34UB67</p>  <p>Stand Base Stand Body Screws x 4</p>		



CAUTION

- Always use genuine components to ensure safety and product performance.
- The product warranty will not cover damage or injury caused by the use of counterfeit components.



NOTE

- Note that the components may look different from those shown here.
- Without prior notice, all information and specifications in this manual are subject to change to improve the performance of the product.
- To purchase optional accessories, visit an electronics store or online shopping site or contact the retail store where you purchased the product.
- The DisplayPort cable may not be available in some areas.

Component and Button Description

29UM67

34UM67

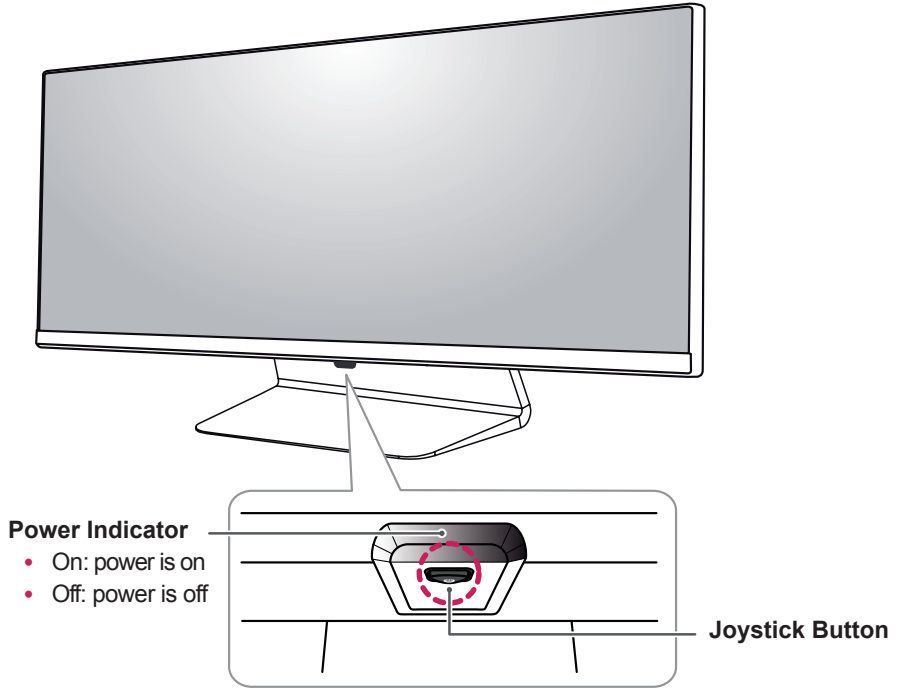

Input Connector

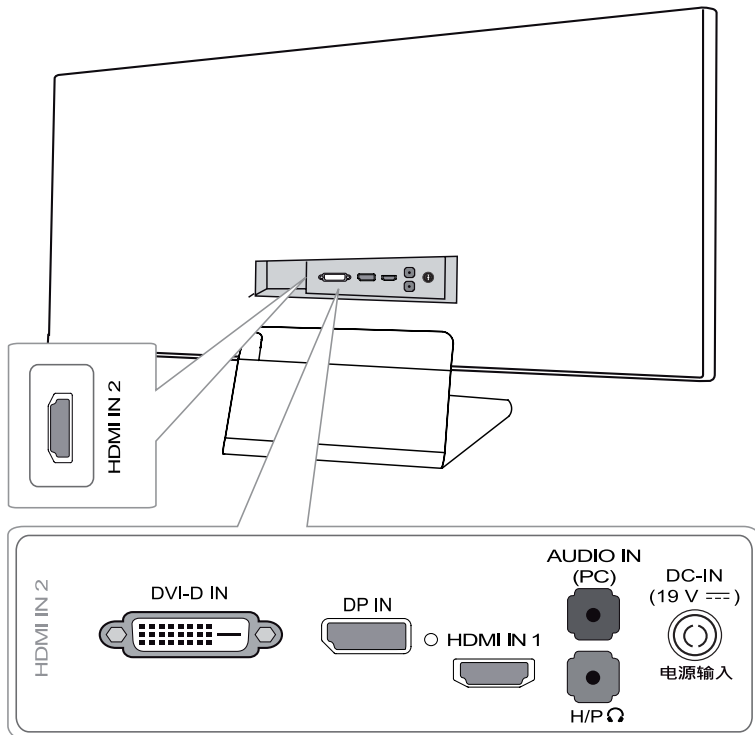

29UB67

ENGLISH

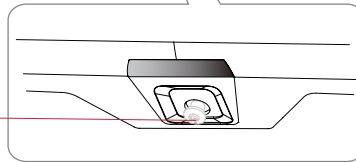
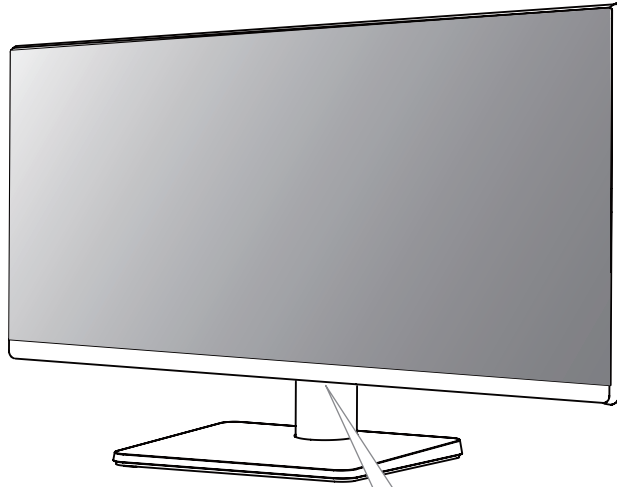

Joystick Button / Power LED

- On: power is on
- Off: power is off

Input Connector

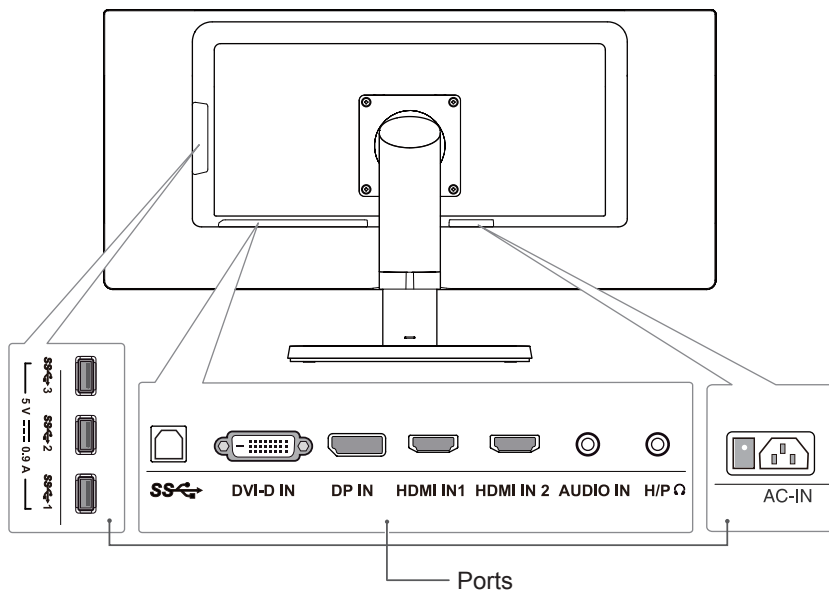

34UB67

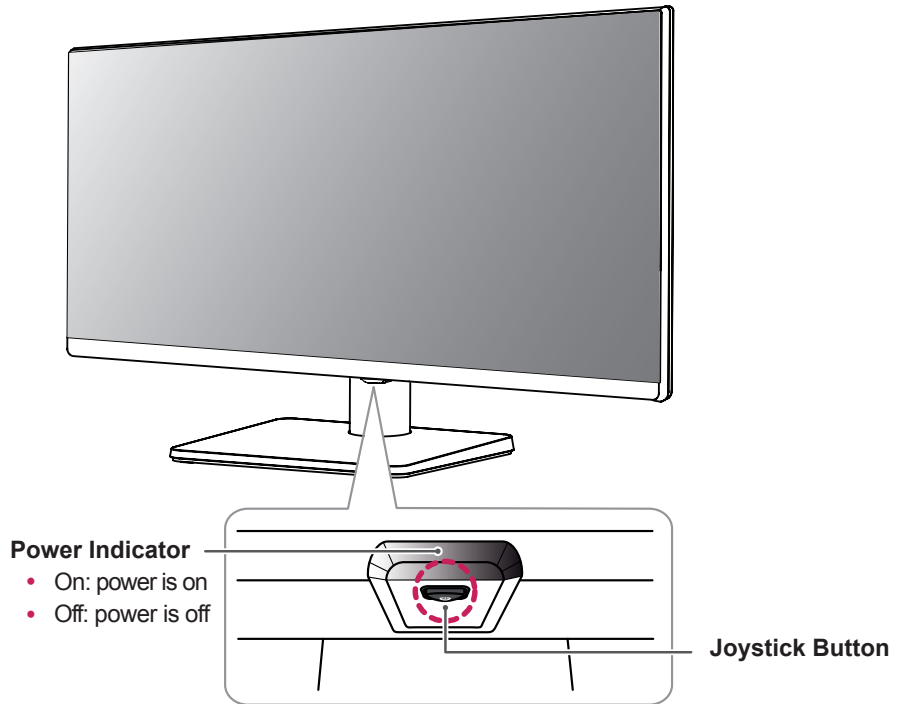



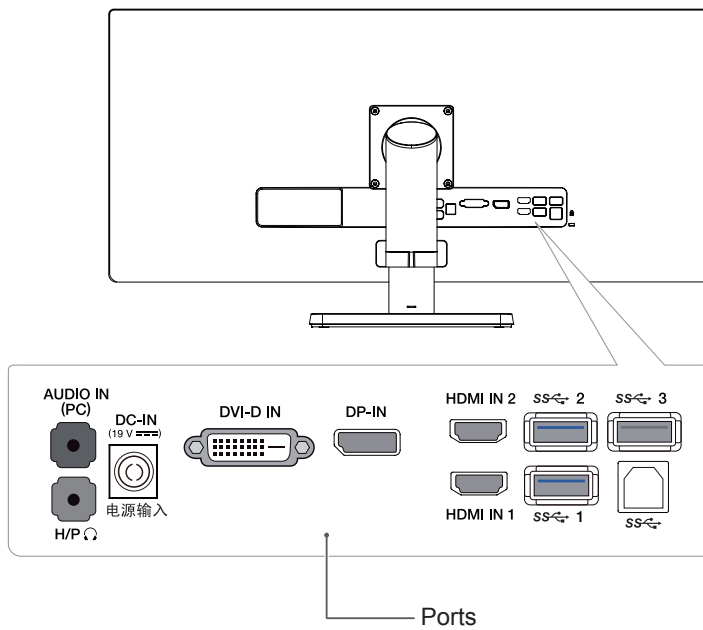

Input Connector



How to Use the Joystick Button

You can easily control the functions of the monitor by pressing the joystick button or moving it left/right with your finger.

Basic Functions

		Power on	Press the joystick button once with your finger to turn on the monitor.
		Power off	Press and hold the joystick button once with your finger to turn off the monitor.
		Volume Control	You can control the volume by moving the joystick button left/right.



NOTE

- The joystick button is located at the bottom of the monitor.

Moving and Lifting the Monitor

When moving or lifting the monitor, follow these instructions to prevent the monitor from being scratched or damaged and to ensure safe transportation regardless of its shape or size.

- It is advisable to place the monitor in the original box or packing material before attempting to move it.
- Before moving or lifting the monitor, disconnect the power cord and all cables.
- Hold the top and bottom of the monitor frame firmly. Do not hold the panel itself.

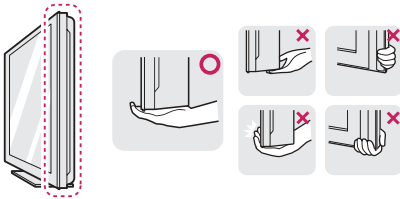

- When holding the monitor, the screen should face away from you to prevent it being scratched.

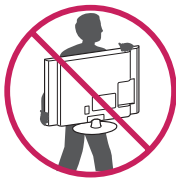

- When moving the monitor, avoid any strong shock or vibrations to the product.
- When moving the monitor, keep it upright, never turn the monitor on its side or tilt it sideways.

! CAUTION

- As far as possible, avoid touching the monitor screen. This may result in damage to the screen or some of the pixels used to create images.

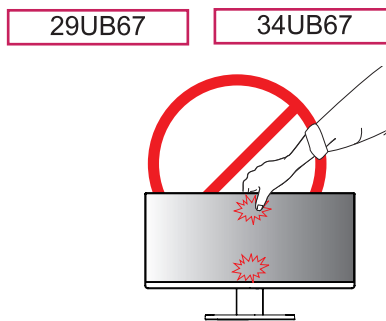
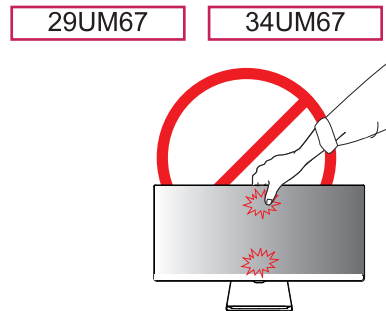

- If you use the monitor panel without the stand base, its joystick button may cause the monitor to become unstable and fall, resulting in damage to the monitor or human injury. In addition, this may cause the joystick button to malfunction.

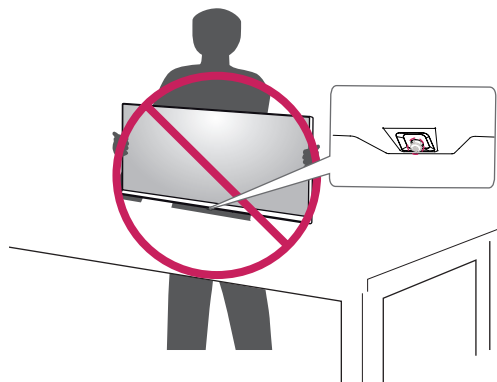

Installing the Monitor

Assembling the stand base

29UM67 34UM67

1 Place the screen face down.



CAUTION

- To protect the screen from scratches, cover the surface with a soft cloth.

2 First, please insert Stand Body to Stand Base, Then tighten two screws into the back of the stand base.

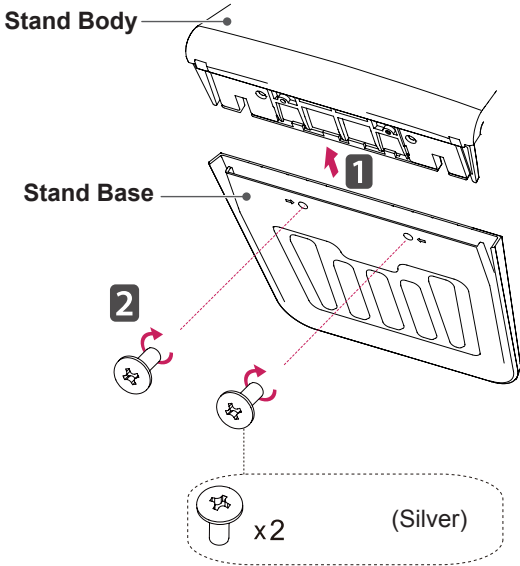

3 Check the direction of the stand body (front, back) and then mount the stand body onto the stand hinge.

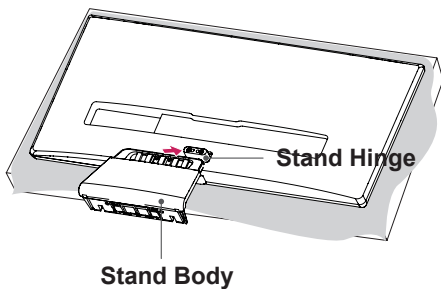

4 Tighten two screws into the back of the stand body .

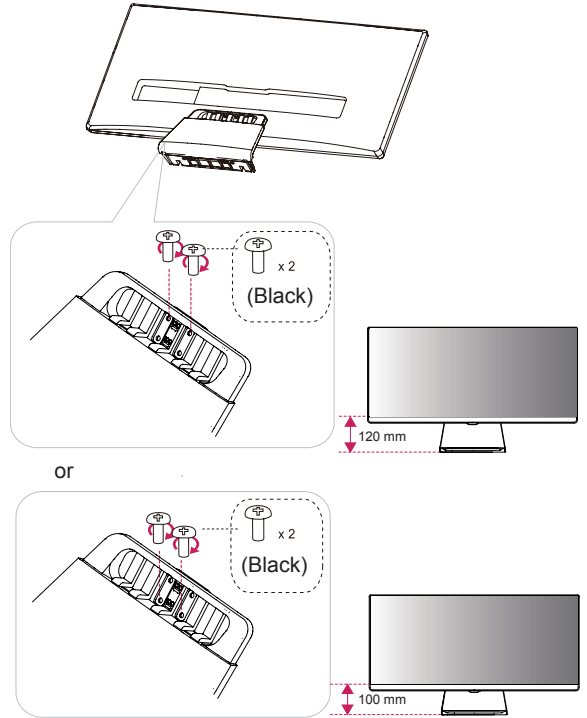

CAUTION

Applying excessive force when tightening the screws may cause damage to the monitor. Damage caused in this way will not be covered by the product warranty.



CAUTION

It may hurt your foot off the stand, so be careful.

29UB67

34UB67

- 1 Place the screen face down.

**CAUTION**

- To protect the screen from scratches, cover the surface with a soft cloth.

- 2 **1** Remove a tape on the surface of stand body. Use a tool to attach the **stand body** as shown in the figure.
- 2** Check the **position (at the front and rear)** of the stand body, then mount the **stand base** on the **stand body** as shown in the figure.
- 3** Tighten the screw to the right.

29UB67

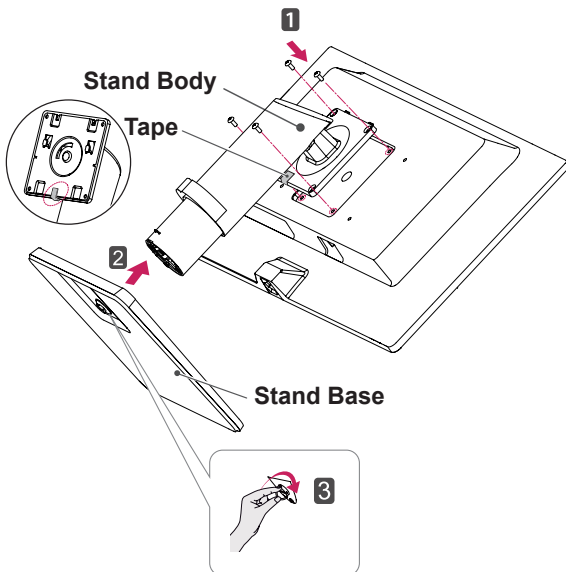

34UB67

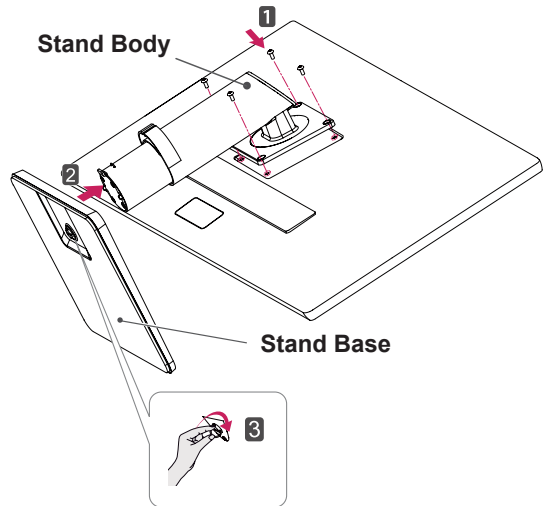
**CAUTION**

- It may hurt your foot off the stand, so be careful.

Using the cable holder

29UB67

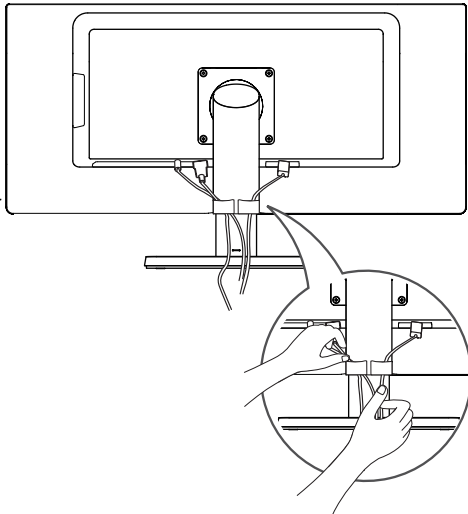

34UB67

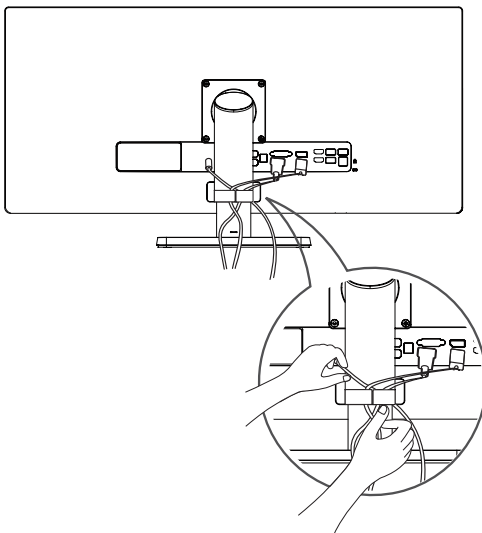

NOTE

- You can disassemble the stand in the reverse order of the assembly.



CAUTION

- Illustrations in this document represent typical procedures, so they may look different from the actual product.
- Applying excessive force when tightening screws may cause damage to the monitor. Damage caused in this way will not be covered by the product warranty.
- Be careful not to hurt your hand on the edges of the screw covers.
- Do not carry the monitor upside down by just holding the base. This may cause the monitor to fall off the stand and could result in personal injury.
- When lifting or moving the monitor, do not touch the monitor screen. The force applied to the monitor screen may cause damage to it.

Installing onto a table

- 1 Lift the monitor and place it on the table in an upright position.

Place at least **10 cm** away from the wall to ensure sufficient ventilation.

29UM67

34UM67

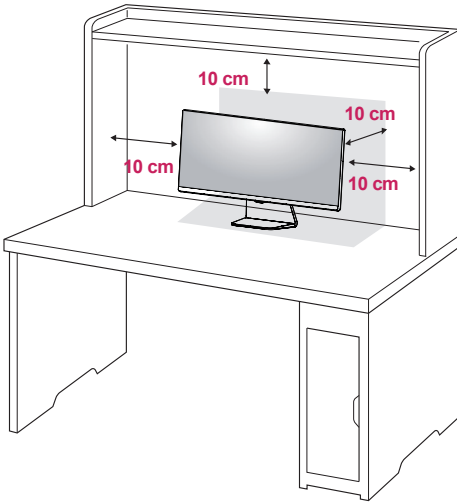

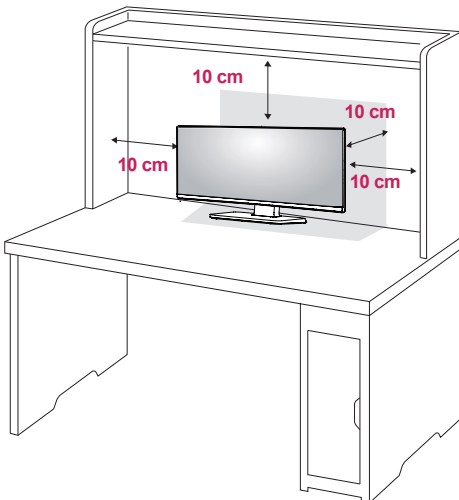

29UB67

34UB67



- 2 Connect the power adapter to the monitor and then plug the power cord into the wall outlet.

29UB67: Press the knob in “” state. (“” Open the power).

29UM67

34UM67

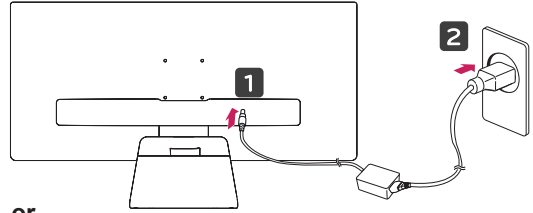

or

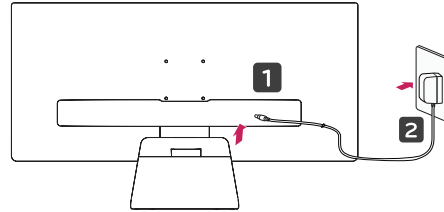

29UB67

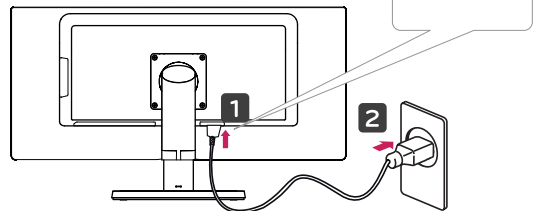

34UB67

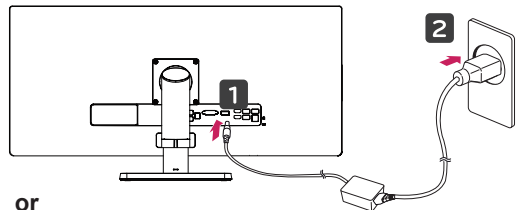

or

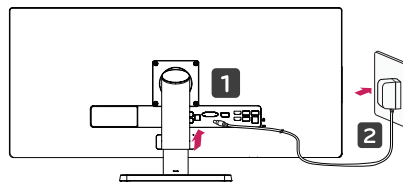

- 3 Press the joystick button on the bottom of the monitor to turn on the monitor.

CAUTION

- Unplug the power cord prior to moving or installing the monitor. There is risk of electric shock.

Adjusting the stand height

29UB67

34UB67

- 1 Stand the monitor assembled with the stand base in an upright position
- 2 Remove the **tape attached to the bottom back of the stand body** and then pull out the **locking pin** while pressing the head downward.

Stand Body

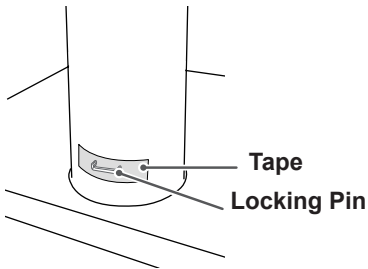

29UB67

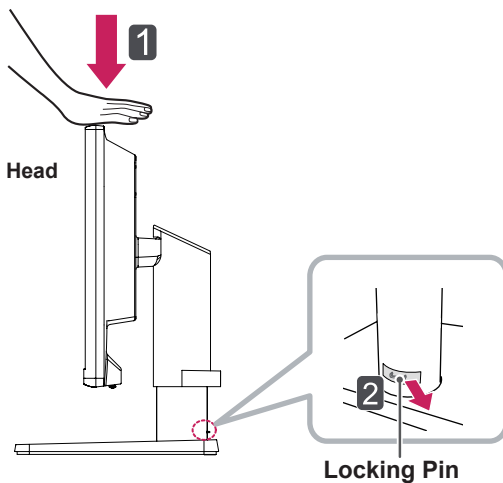

34UB67

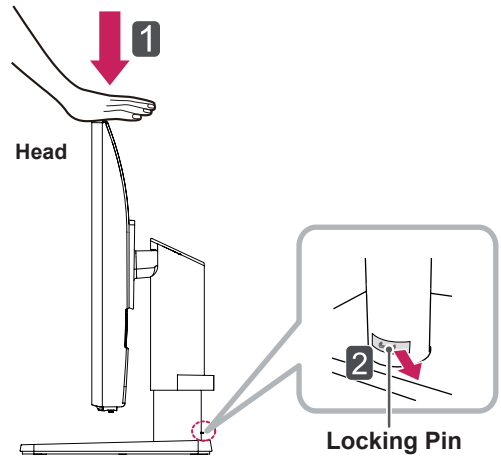

- 3 The height can be adjusted up to **130.0 mm**.

29UB67

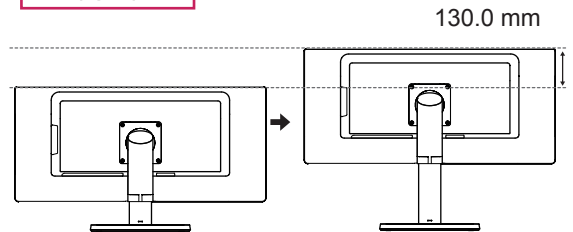

34UB67

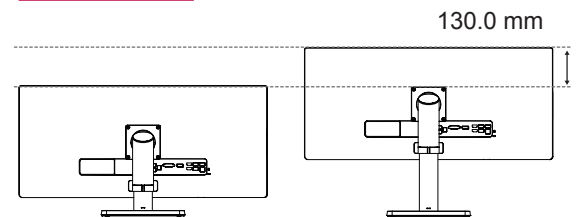

CAUTION

- Once the pin is removed, it is not necessary to re-insert it to adjust the height.

WARNING

- Do not put your fingers or hand between the screen and the base (chassis) when adjusting the screen's height.

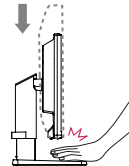

Adjusting the angle

- 1 Place the monitor in an upright position, mounted on the stand base.
- 2 Adjust the angle of the screen. The angle of the screen can be adjusted forwards or backwards for a comfortable viewing experience.

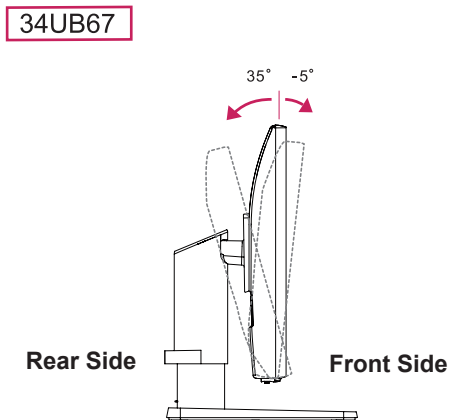
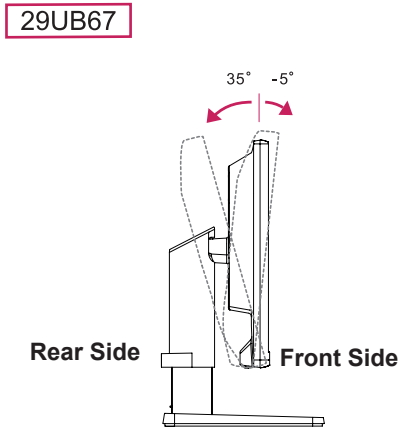
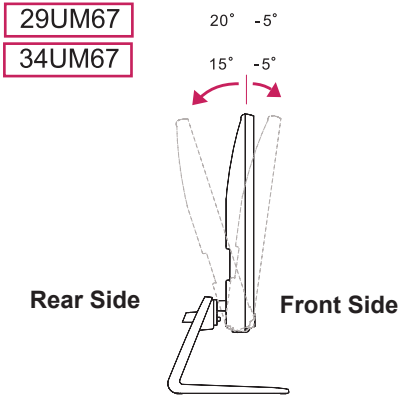

! WARNING

- To avoid injury to the fingers when adjusting the screen, do not hold the lower part of the monitor's frame as illustrated below.

29UM67 **34UM67**

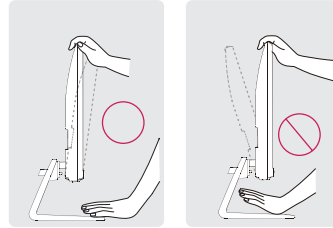

29UB67

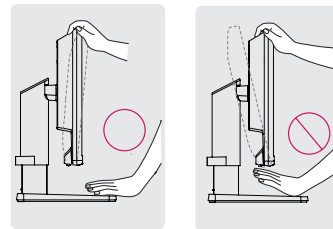

34UB67

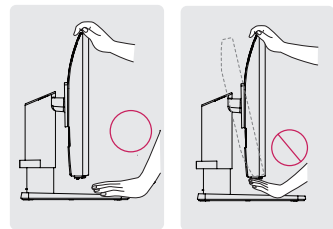

- Be careful not to touch or press the screen area when adjusting the angle of the monitor.

29UM67 **34UM67**

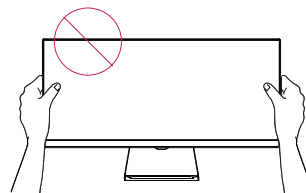

29UB67 **34UB67**

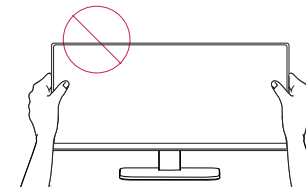

29UB67

ENGLISH

Pivot feature

The pivot feature allows the monitor to rotate 90° clockwise.

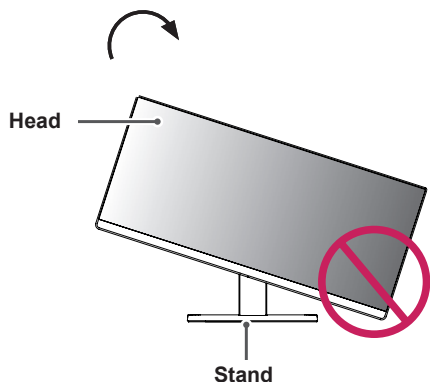

! WARNING

- To avoid scratching the stand base, make sure that when rotating the monitor using the pivot feature, the stand does not make contact with the monitor.

- 1 Raise the monitor up to the maximum height.

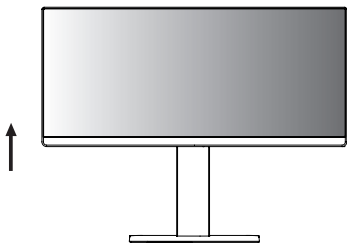

- 2 Adjust the angle of the monitor in the direction of the arrow as shown in the figure.

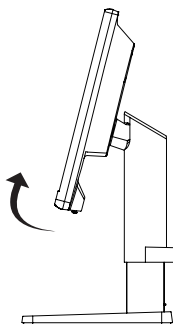

- 3 Rotate the monitor clockwise as shown in the figure.

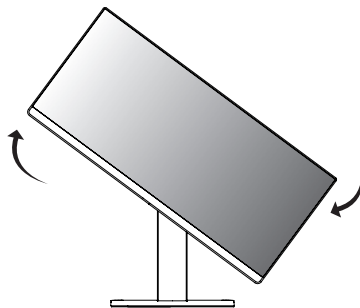

- 4 Complete the installation by rotating the monitor 90° as shown below.



! WARNING

- To avoid injury to the fingers when adjusting the screen, do not hold the lower part of the monitor's frame as illustrated below.

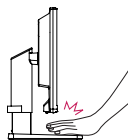

! WARNING

- Take care when rotating the monitor if the cable is connected.

! NOTE

- An image displayed on the monitor's screen does not rotate according to the screen orientation.

Using the Kensington lock

The Kensington security system connector is located at the back of the Monitor set.

For more information on installation and usage, refer to the Kensington lock user manual or visit the website at <http://www.kensington.com>.

Connect the Kensington security system cable between the Monitor set and a table.

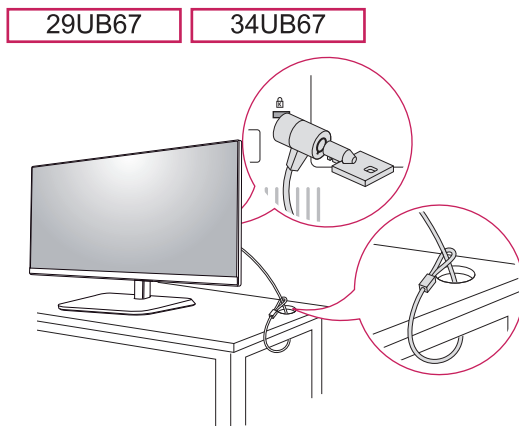
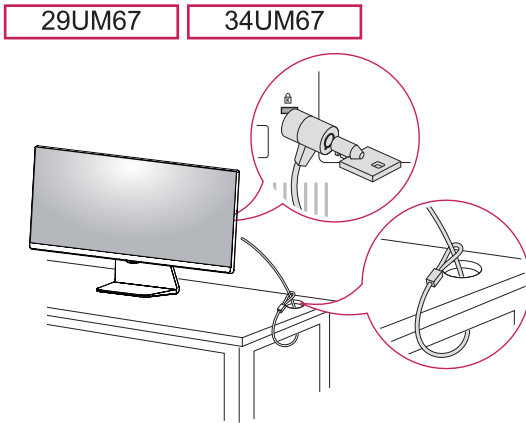

! NOTE

- Use of the Kensington lock is optional. The accessories can be purchased at your local electronics store.

Installing the wall mount plate

This monitor supports the specification of the standard wall mount plate or compatible device.

- 1 Place the screen face down. To protect the screen from scratches, cover the surface with a soft cloth.
- 2 Place the wall mount plate onto the monitor and align it with the screw holes.
- 3 Using a screwdriver, tighten the four screws to fix the plate onto the monitor.

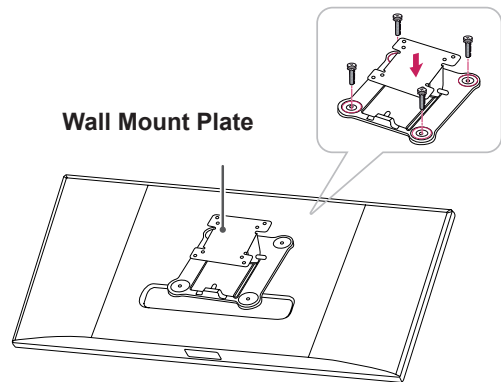

! NOTE

- The wall mount plate is sold separately.
- For more information on installation, refer to the wall mount plate's installation guide.
- Be careful not to use excessive force when mounting the wall mount plate, as this can damage the monitor's screen.

Installing to a wall

Install the monitor at least 10 cm away from the wall and leave about 10 cm of space at each side of the monitor to ensure sufficient ventilation. Detailed installation instructions can be obtained from your local retail store. Please refer to the manual to install and set up a tilting wall mounting bracket.

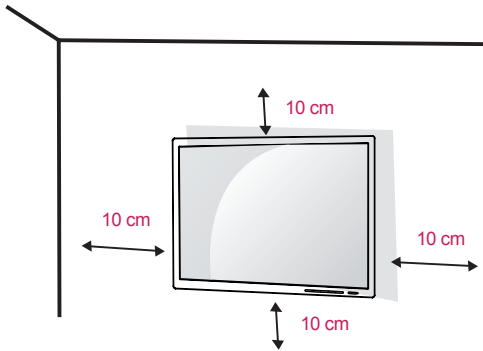

To install the monitor to a wall, attach a wall mounting bracket (optional) to the back of the monitor. Make sure that the wall mounting bracket is securely fixed to the monitor and to the wall.

- 1 If you use screw longer than standard, the monitor might be damaged internally.
- 2 If you use improper screw, the product might be damaged and drop from mounted position. In this case, LG Electronics is not responsible for it.

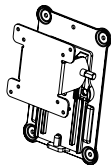
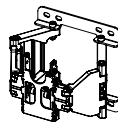
Model	29UM67	34UM67 34UB67	29UB67
Wall Mount (A x B)	75 x 75	100 x 100	200 x 100
Standard screw	M4 x L10		M4 x L10
Number of screws	4		4
Wall Mount Plate (Optional)	RW120 		LSW140 

- Wall Mount (A x B)

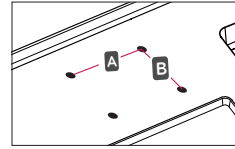

CAUTION

- Unplug the power cord before moving or installing the monitor to avoid electric shocks.
- Installing the monitor on the ceiling or on a slanted wall may result in the monitor falling off, which could lead to injury. Please use the genuine LG wall mounting bracket. For more information, contact your local retail store or a qualified installer.
- Applying excessive force when fastening screws may cause damage to the monitor. Damage caused in this way will not be covered by the product warranty.
- Use the wall mounting bracket and screws that conform to the VESA standard. Damage caused by the use or misuse of inappropriate components will not be covered by the product warranty.
- Screw length from outer surface of back cover should be under 8mm.

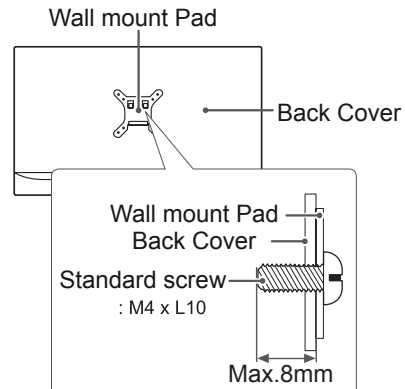

NOTE

- Use the screws specified by the VESA standard.
- The wall mount kit includes the installation guide and all necessary parts.
- The wall mounting bracket is optional. The accessories can be purchased at your local retail store.
- The length of the screw may differ for each wall mounting bracket. Ensure the correct length screw is used.
- For more information, please refer to the user manual for the wall mounting bracket.

USING THE MONITOR

Connecting to a PC

- This monitor supports the *Plug and Play feature.
*Plug and Play: A feature that allows you to add a device to your computer without having to reconfigure anything or install any manual drivers.

DVI connection

Transmits digital video signals to the monitor. Connect the monitor using the DVI cable as illustrated below.

Press the menu button and then select the input option from the input menu.

To hear the sound in DVI input mode, connect the PC's AUDIO OUT port to the monitor's AUDIO IN (PC) port using the audio cable that came with the product.

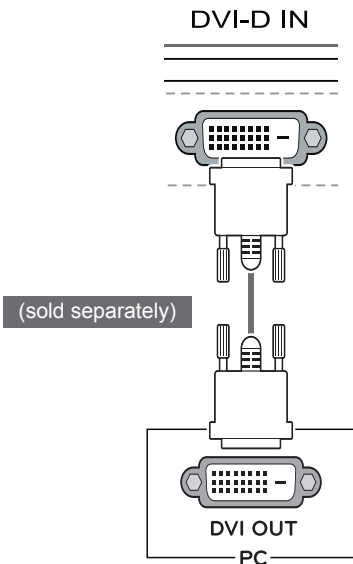

CAUTION

- Connect the input signal cable and turn in the direction of the arrow. To prevent disconnection secure the cable tightly.
- Do not press on the screen for a prolonged period of time. This may cause image distortion.
- Do not display a still image on the screen for a prolonged period of time. This may cause image retention. If possible, use the screen saver.

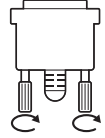

NOTE

- When connecting the power cord to the outlet, use a grounded (3-hole) multi-socket or a grounded power outlet.
- The monitor may flicker when turned on in an area of low temperature. This is normal.
- Sometimes red, green, or blue spots may appear on the screen. This is normal.
- Using a DVI to HDMI cable may cause compatibility issues.

DisplayPort connection

Transmits the digital video and audio signals from your PC to the monitor. Connect your PC to the monitor using the display port cable as illustrated below.

Press the menu button and then select the input option from the input menu.

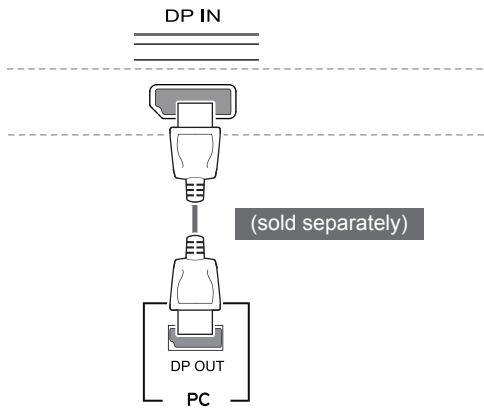

NOTE

- There may be no video or audio output depending on the DP version of the PC.
- The DisplayPort cable may not be available in some areas.

HDMI connection

Transmits the digital video and audio signals from your PC and A/V devices to the monitor. Connect your PC and AV device to the monitor with the HDMI cable as illustrated below.

Press the menu button and then select the input option from the input menu.

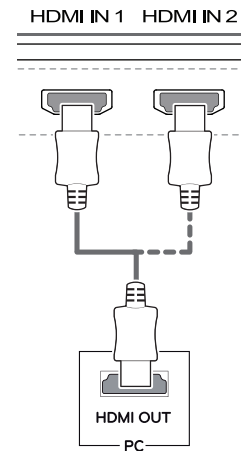

NOTE

- If you use HDMI PC, it can cause compatibility problem.
- Use a certified cable with the HDMI logo attached. If you do not use a certified HDMI cable, the screen may not display or a connection error may occur.
- Recommended HDMI cable types
 - High-Speed HDMI[®]/TM Cable
 - High-Speed HDMI[®]/TM Cable with Ethernet

Connecting to AV Devices

HDMI connection

Transmits the digital video and audio signals from your PC and A/V devices to the monitor. Connect your PC and AV device to the monitor with the HDMI cable as illustrated below.

Press the menu button and then select the input option from the input menu.

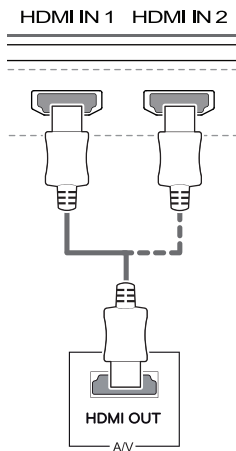

NOTE

- If you use HDMI PC, it can cause compatibility problem.
- Use a certified cable with the HDMI logo attached. If you do not use a certified HDMI cable, the screen may not display or a connection error may occur.
- Recommended HDMI cable types
 - High-Speed HDMI^{®/TM} Cable
 - High-Speed HDMI^{®/TM} Cable with Ethernet

Connecting to External Devices

USB Cable connection - PC

The USB port on the product functions as a USB hub.

NOTE

- Make sure to install the most recent Windows OS service pack before using the product.
- Peripheral devices are sold separately.
- A keyboard, mouse, or USB device can be connected to the USB port.

CAUTION

Cautions When Using a USB Device

- A USB device with an automatic recognition program installed, or that uses its own driver, may not be recognized.
- Some USB devices may not be supported or may not work properly.
- It is recommended to use a USB hub or hard disk drive with power supplied. (If the power supply is not adequate, the USB device may not be recognized properly.)

29UB67

34UB67

To use USB 3.0, connect the A-B type USB 3.0 cable of the product to the PC. Peripheral devices connected to the USB IN port can be controlled from the PC.

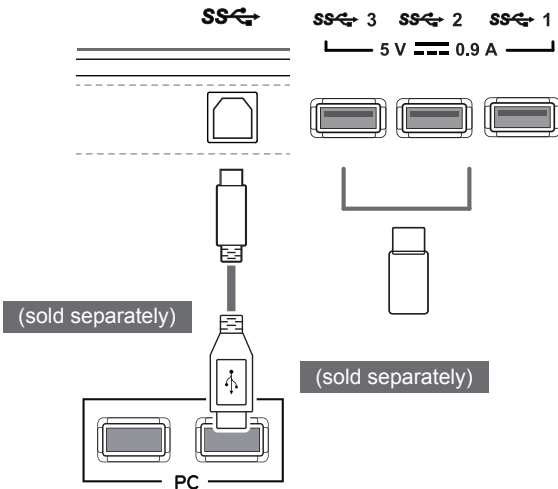

Connecting Headphones

Connect peripherals to the monitor via the headphones port. Connect as illustrated.

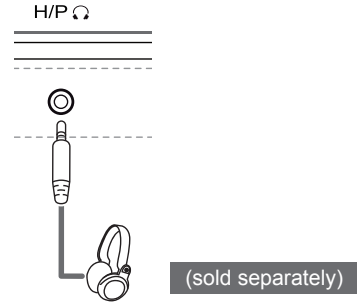

NOTE

- Peripheral devices are sold separately.
- If you use angled earphones, it may cause a problem with connecting another external device to the monitor. Therefore, it is recommended to use straight earphones.



Angled

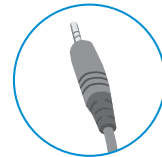

Straight

- Depending on the audio settings of the PC and external device, headphones and speaker functions may be limited.

INSTALLING LG MONITOR SOFTWARE

Insert the the owner's manual CD included in the product package into your PC's CD driver and install the LG Monitor Software.

1 Set the default Web browser to Internet Explorer.

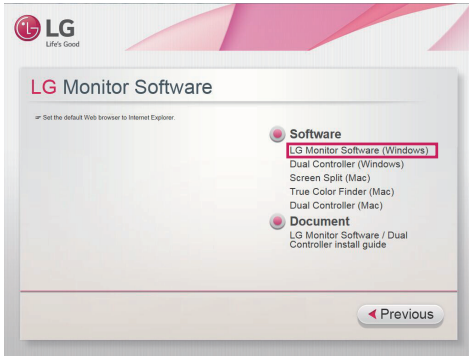

2 Click the "LG Monitor Software" on the CD's main screen. When the file download window appears, click the Run button. (The file download window may vary depending on the operating system and the Internet Explorer version, but the installation procedures are same.)

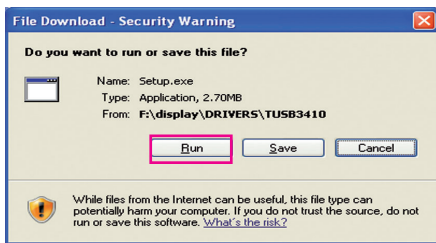

4 Check "I accept the terms of the agreement" on the License Agreement screen and then click the [Next] button.

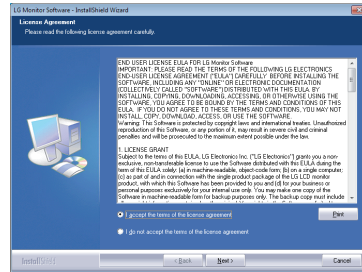

5 Select the program that you want to install.

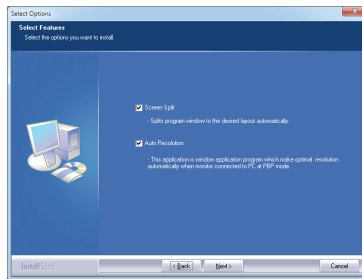

NOTE

- Screen Split: This program automatically splits the program window as desired.
- True Color Finder: This program calibrates the precise color output of the monitor to suit your needs.

CAUTION

- Service Pack 1 or higher is required for Windows 7.

3 Follow the instructions to proceed with the installation.

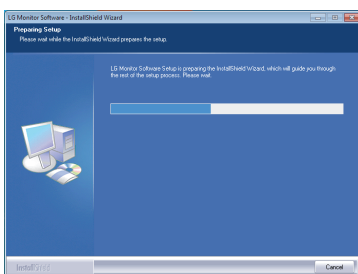

- 6 The LG Monitor Software installation starts as shown below.

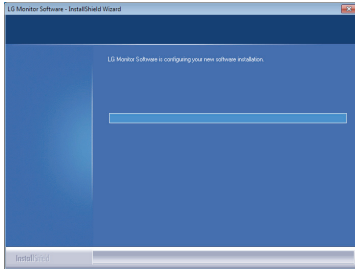

- 8 The program you selected on the Select Features page will install automatically.

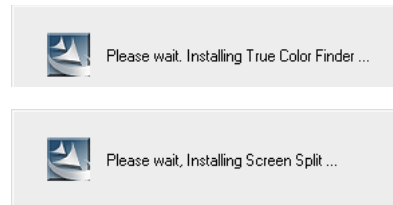

- 7 If the TUSB3410 driver has not been installed, it will install automatically. Select "Install this driver software anyway (I)" if the Windows security message is displayed as below.

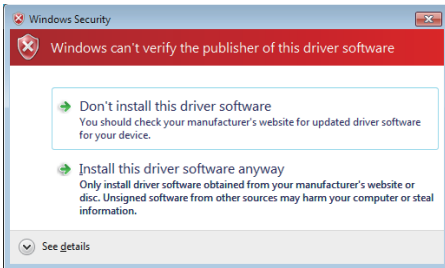
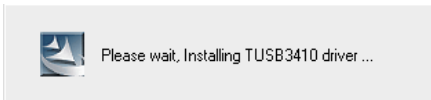

- 9 When the installation is complete, restart your system.

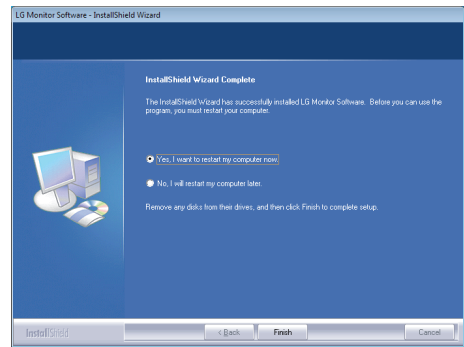

NOTE

When you run the True Color Finder software, the True Color Finder icon [] appears in the system tray at the right bottom of the PC screen.

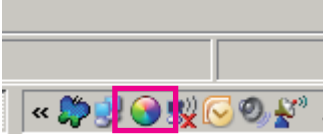

Right-click the True Color Finder icon and select "Start Program" to start the program.

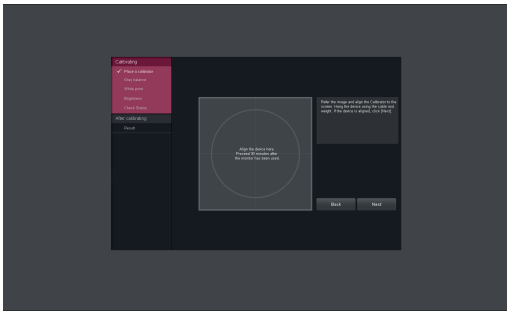

NOTE

- To use the True Color Finder function, you must purchase the supported calibrator.
- For details on supported calibrators and graphic cards, see the True Color Finder user guide.
- If you have changed the input port, it is recommend that you calibrate the monitor's picture quality again.

NOTE

If you run Screen Split, the Screen Split icon [] appears in the system tray at the right bottom of the PC screen.



Right-click the Screen Split icon and select a layout you want.

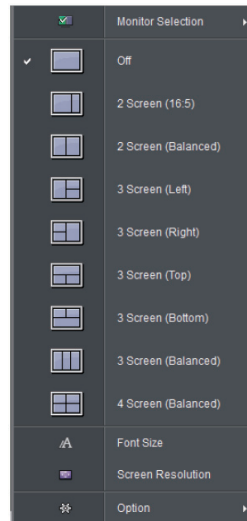

CAUTION

- Once you have completed the monitor calibration with the True Color Finder software, remove the calibrator from the monitor and store it at room temperature away from direct sunlight or put it in the box.
 - If the calibrator's measuring part is exposed to direct sunlight for a long time, this may cause damage to the calibrator.
 - Do not store it in an environment with too low/high temperature and high humidity.
- If any third-party calibration application is already installed on your PC, the image quality may be affected by a conflict between the two applications. For the best performance, it is recommended to uninstall the other calibration application.

Installing The Dual Controller

Insert the software CD included in the product packaging into your PC's CD drive and install the Dual Controller.

The installation screen images are for reference only. The actual installation screen images may vary depending on the model.

- 1 Set the default Web browser to Internet Explorer.

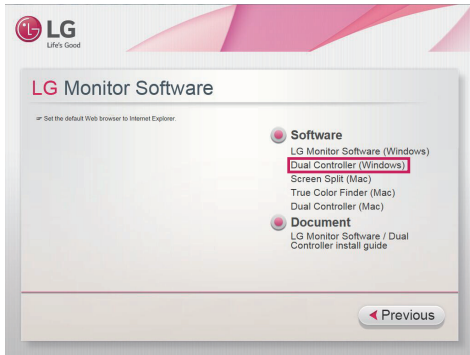

- 2 Click the "Dual Controller" on the CD's main screen. When the file download window appears, click the Run button. (The file download window may vary depending on the operating system and the Internet Explorer version, but the installation procedures are same.)

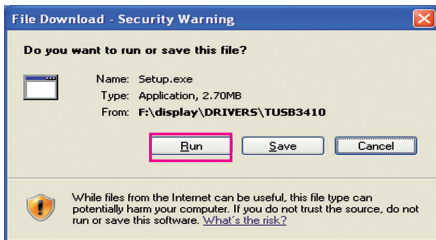

- 3 Follow the instructions to proceed with the installation.

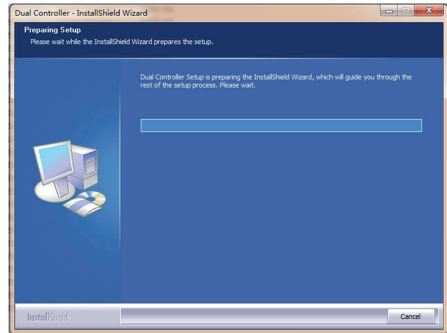

- 4 Check "I accept the terms of the agreement" on the License Agreement screen and then click the [Next] button.

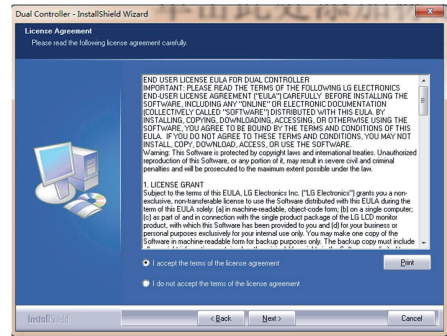

- 5 Click the install button.

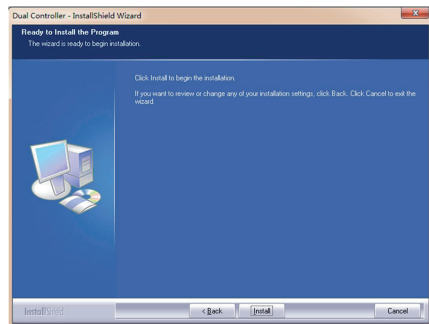

CAUTION

- Service Pack 1 or higher is required for Windows 7 & Windows 8.1.

6 The Dual Controller installation starts as shown below.

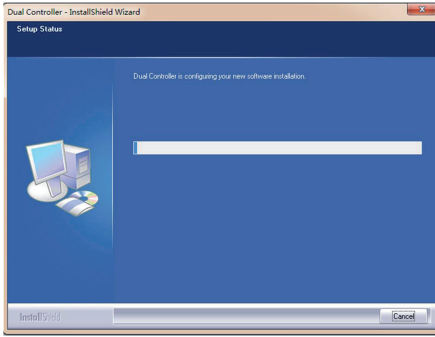

7 When the installation is complete, restart your system.

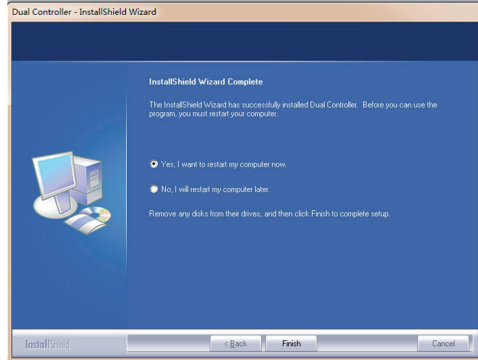

NOTE

If you run Dual Controller, the Dual Controller icon [] appears in the system tray.



Click the Dual Controller icon and select a layout you want.

- * Run as Main PC mode
- * Run as Sub PC mode
- * Open Dual Controller
- * Select Network Card
- * Exit



USER SETTINGS

ENGLISH

Activating the Main Menu

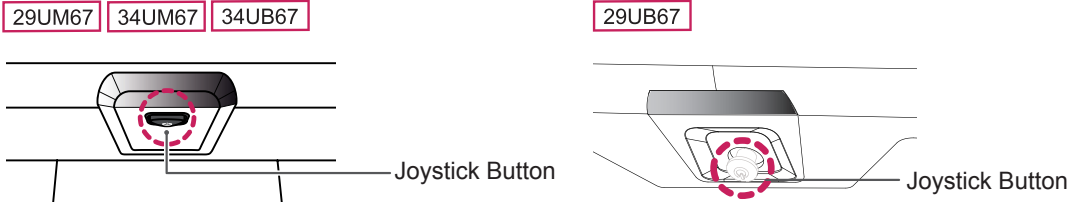
- 1 Press the joystick button on the bottom of the monitor.
- 2 Move the joystick up/down (▲/▼) and left/right(◀/▶) to set the options.
- 3 Press the joystick button once more to exit the main menu.



Button	Menu Status	Description
	Main menu disabled	Enables the main menu.
	Main menu enabled	Exits the main menu. (Holding down the button to turn off the monitor. You can turn off the monitor this way at any time, including when the OSD is on.)
	◀ Main menu disabled	Adjusts the monitor volume level.
	◀ Main menu enabled	Enters the menu features.
	▶ Main menu disabled	Adjusts the monitor volume level.
	▶ Main menu enabled	Enters the PBP feature.
	▲ Main menu disabled	Enables the main menu.
	▲ Main menu enabled	Enters the picture mode feature.
	▼ Main menu disabled	Enables the main menu.
	▼ Main menu enabled	Turns off the monitor.

Main Menu Features

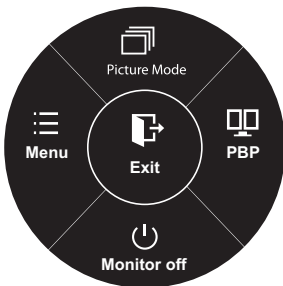

Main Menu	Description
Menu	Configures the screen settings.
Picture Mode	Select picture mode to achieve the best display effect.
PBP	Displays the screens of two input modes on one monitor.
Monitor off	Turns off the monitor.
Exit	Exits the main menu.

Ⓞ Long press: Monitor off

Customizing settings

Menu Settings

-Quick Settings

- 1 To view the **OSD menu**, press the **joystick button** at the bottom of the monitor and then enter the **Menu**.
- 2 Go to **Quick Settings > Brightness** by moving the joystick.
- 3 Configure the options following the instructions that appear in the bottom right corner.
- 4 To return to the upper menu or set other menu items, move the joystick to ◀ or pressing (⊙ / OK) it.
- 5 If you want to exit the OSD menu, move the joystick to ◀ until you exit.

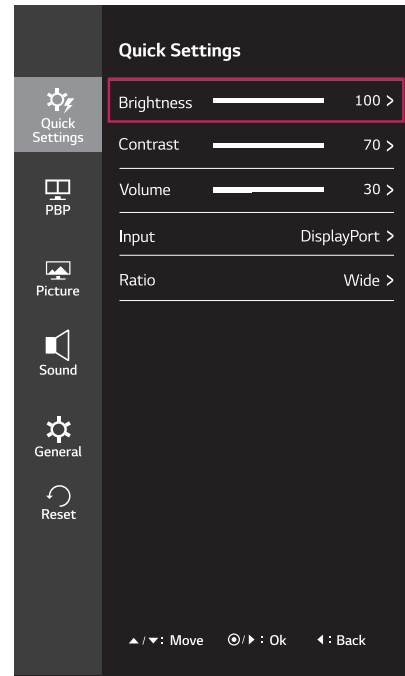

Each option is described below.

Menu > Quick Settings	Description				
Brightness	Adjusts the color contrast and brightness of the screen.				
Contrast					
Volume	Adjusts the volume.				
	<div style="border: 1px solid black; padding: 5px;"> <p>NOTE</p> <ul style="list-style-type: none"> • Jog joystick button down (⊙) in the Volume menu will enable/disable the Mute function. </div>				
Input	Selects the current input mode.				
Ratio	Adjusts the screen ratio.				
	<table border="1"> <tr> <td>Wide</td> <td>Displays the video in wide-screen, regardless of the video signal input.</td> </tr> <tr> <td>Original</td> <td>Displays a video according to the input video signal aspect ratio.</td> </tr> </table>	Wide	Displays the video in wide-screen, regardless of the video signal input.	Original	Displays a video according to the input video signal aspect ratio.
Wide	Displays the video in wide-screen, regardless of the video signal input.				
Original	Displays a video according to the input video signal aspect ratio.				

NOTE

- The display may look the same for Wide, Original options at the recommended resolution (2560 x 1080).
- The ratio is disabled in the interlaced signal.

-PBP

- 1 To view the **OSD menu**, press the **joystick button** at the bottom of the monitor and then enter the **Menu**.
- 2 Go to **PBP** by moving the joystick.
- 3 Configure the options following the instructions that appear in the bottom right corner.
- 4 To return to the upper menu or set other menu items, move the joystick to ◀ or pressing (⊙ / OK) it.
- 5 If you want to exit the OSD menu, move the joystick to ◀ until you exit.

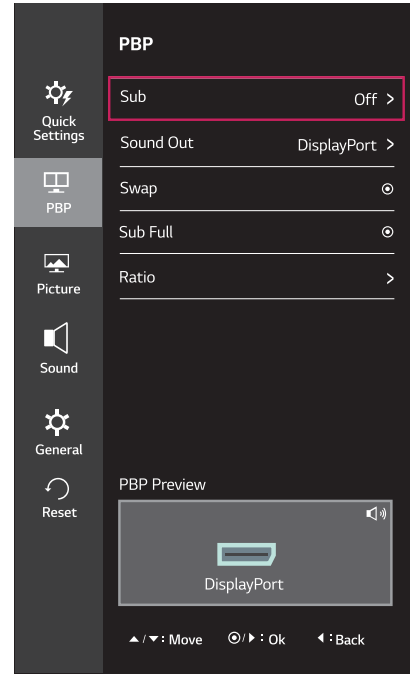

Each option is described below.

Menu > PBP	Description		
Sub	Selects the video signal input of the sub screen.		
Sound Out	Sound Out have four options.HDMI1, HDMI2, DP, Audio-In.		
Swap	Toggles between the main screen and sub screen in PBP mode.		
Sub Full	Converts the sub screen of PBP mode to the wide screen.		
Ratio	Adjusts the aspect ratio of the main screen or sub screen.		
	Main	Wide	Displays the video to fit the PBP screen, regardless of the video signal input.
		Original	Displays the video in the aspect ratio of the video signal input on the PBP screen.
	Sub	Wide	Displays the video to fit the PBP screen, regardless of the video signal input.
Original		Displays the video in the aspect ratio of the video signal input on the PBP screen.	

-Picture

- 1 To view the **OSD menu**, press the **joystick button** at the bottom of the monitor and then enter the **Menu**.
- 2 Go to **Picture** by moving the joystick.
- 3 Configure the options following the instructions that appear in the bottom right corner.
- 4 To return to the upper menu or set other menu items, move the joystick to ◀ or pressing (⊙ / OK) it.
- 5 If you want to exit the OSD menu, move the joystick to ◀ until you exit.

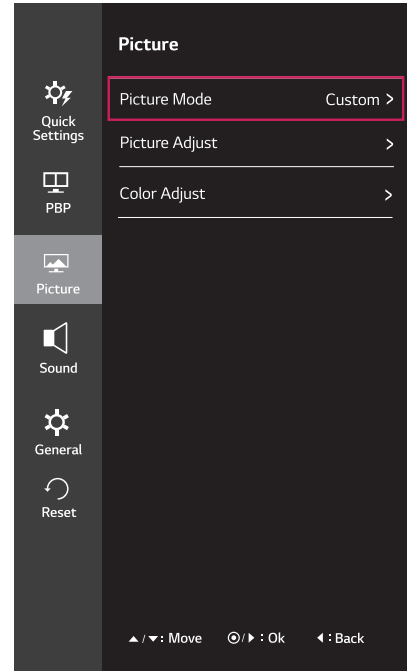

Each option is described below.

Menu > Picture	Description	
Picture Mode	Custom	Allows the user to adjust each element. The color mode of the main menu can be adjusted.
	Photo	Optimizes the screen to view photos.
	Cinema	Optimizes the screen to improve the visual effects of a video.
	Game	Optimizes the screen for gameplay.
	Reader 1	It is a mode that the screen is adjusted to the best for the newspaper. If you want screen more bright, you can control brightness in Menu OSD.
	Reader 2	It is a mode that the screen is adjusted to the best for the cartoon. If you want screen more bright, you can control brightness in Menu OSD.
	Calibration	Applies the value calibrated by True Color Finder.
	<div style="border: 1px solid black; padding: 10px;"> <p>NOTE</p> <ul style="list-style-type: none"> • Run the True Color Finder program. • Calibration settings for DVI / HDMI / DP(DisplayPort) will be saved separately. </div>	

Picture Adjust	Sharpness	Adjusts the sharpness of the screen.		
	Black Level	Sets the offset level (for HDMI only). • Offset: as a reference for a video signal, this is the darkest color the monitor can display.		
		High	The picture of the screen gets brighter.	
		Low	The picture of the screen gets darker.	
	Response Time	Sets a response time for displayed pictures based on the speed of the screen. For a normal environment, it is recommended that you use Normal. For a fast-moving picture, it is recommended that you use High. Setting to High may cause image sticking.		
		High	Sets the response time to High.	
		Middle	Sets the response time to Middle.	
		Low	Sets the response time to Low.	
	Off	Sets the response time to Off.		
Color Adjust	Gamma	Set your own gamma value. : Gamma 0, Gamma 1, Gamma 2 on the monitor, high gamma values display whitish images and low gamma values display blackish images. If user don't want adjusted gamma, user can select Gamma off.		
	Color Temp	Selects the factory default picture color. Warm: Sets the screen color to a reddish tone. Medium: Sets the screen color between a red and blue tone. Cool: Sets the screen color to a bluish tone.		
		Custom		
		Red Green Blue	You can customize the picture color using Red, Green, and Blue colors.	
	Six Color	Meets the user requirements for colors through adjusting the color and saturation of the six colors(Red_Hue, Red_Saturation, Green_Hue, Green_Saturation, Blue_Hue, Blue_Saturation, Cyan_Hue, Cyan_Saturation, Magenta_Hue, Magenta_Saturation, Yellow_Hue, Yellow_Saturation, Reset) and saving the settings.		
*Hue: Adjusts tone of the screen. *Saturation: Adjusts the saturation of the screen colors. The lower the value, less saturated and bright the colors become. The higher the value, the more saturated and dark the colors become.				
	Reset	Returns the color settings to the default settings.		

-Sound

- 1 To view the **OSD menu**, press the **joystick button** at the bottom of the monitor and then enter the **Menu**.
- 2 Go to **Sound** by moving the joystick.
- 3 Configure the options following the instructions that appear in the bottom right corner.
- 4 To return to the upper menu or set other menu items, move the joystick to ◀ or pressing (⊙ / OK) it.
- 5 If you want to exit the OSD menu, move the joystick to ◀ until you exit.

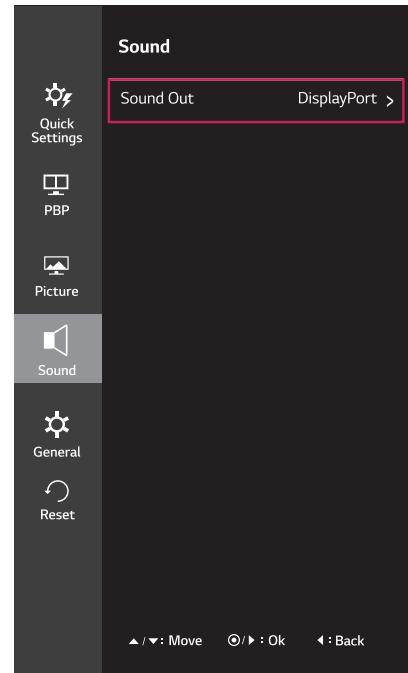

Each option is described below.

Menu > Sound	Description
Sound Out	Sound Out have four options.HDMI1, HDMI2, DP, Audio-In.

-General

- 1 To view the **OSD menu**, press the **joystick button** at the bottom of the monitor and then enter the **Menu**.
- 2 Go to **General** by moving the joystick.
- 3 Configure the options following the instructions that appear in the bottom right corner.
- 4 To return to the upper menu or set other menu items, move the joystick to ◀ or pressing (⊙ / OK) it.
- 5 If you want to exit the OSD menu, move the joystick to ◀ until you exit.

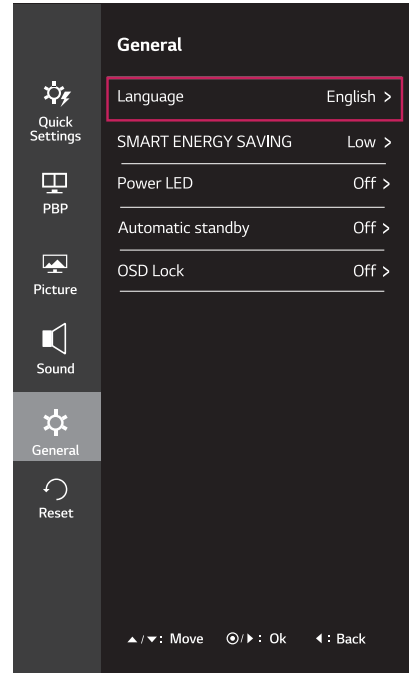

Each option is described below.

Menu > General	Description	
Language	To choose the language in which the control names are displayed.	
SMART ENERGY SAVING	High	Enables SMART ENERGY SAVING you can save energy with this energy- high efficient function.
	Low	Enables SMART ENERGY SAVING you can save energy with this energy- low efficient function.
	Off	Disables SMART ENERGY SAVING .
Power LED	Turns the power indicator on the front side of the monitor on/off.	
	On	The power indicator is automatically turned on.
	Off	The power indicator is turned off.
Automatic Standby	The monitor will automatically switch to standby mode after a certain period.	
OSD Lock	Prevents incorrect key input.	
	On	Key input is disabled.
	<div style="border: 1px solid black; padding: 5px;"> <p>NOTE All functions except for the OSD Lock mode and the Exit button for Brightness, Contrast, Volume, Input, and General are disabled.</p> </div>	
	Off	Key input is enabled.

* SMART ENERGY SAVING : Conserve energy by using luminance compensation algorithm.

NOTE

- Saving Data depends on the Panel. So,those values should be different from each panel and panel vendor.If option of SMART ENERGY SAVING is High or Low, monitor luminance become higher or lower depend on source.
- If option of SMART ENERGY SAVING is High or Low, Picture Mode will automatically be Custom.

-Reset

- 1 To view the **OSD menu**, press the **joystick button** at the bottom of the monitor and then enter the **Menu**.
- 2 Go to **Reset** by moving the joystick.
- 3 Configure the options following the instructions that appear in the bottom right corner.
- 4 To return to the upper menu or set other menu items, move the joystick to ◀ or pressing (⊙ / OK) it.
- 5 If you want to exit the OSD menu, move the joystick to ◀ until you exit.

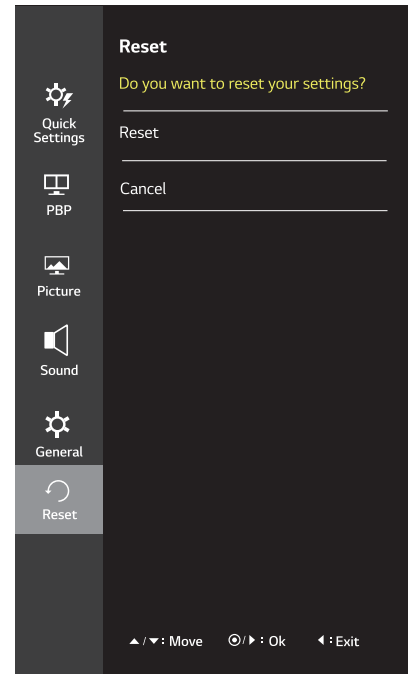

Each option is described below.

Menu > Reset	Description
Do you want to reset your settings?	
Reset	Returns to the default settings.
Cancel	Cancel the select.

-Picture mode

- 1 Press the joystick button on the bottom of the monitor.
- 2 Go to **Picture mode** by moving the joystick button to ▲.
- 3 Configure the options following the instructions that appear in the bottom.

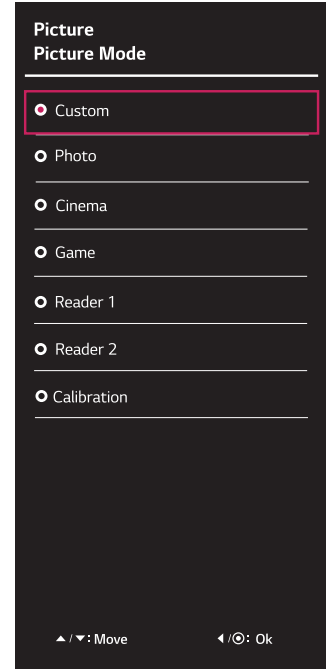

Each option is described below.

Joystick Button > Picture Mode	Description	
Picture Mode	Custom	Allows the user to adjust each element. The color mode of the main menu can be adjusted.
	Photo	Optimizes the screen to view photos.
	Cinema	Optimizes the screen to improve the visual effects of a video.
	Game	Optimizes the screen for gameplay.
	Reader 1	It is a mode that the screen is adjusted to the best for the newspaper. If you want screen more bright, you can control brightness in Menu OSD.
	Reader 2	It is a mode that the screen is adjusted to the best for the cartoon. If you want screen more bright, you can control brightness in Menu OSD.
	Calibration	Applies the value calibrated by True Color Finder. <div style="border: 1px solid black; padding: 10px; margin-top: 10px;"> <p>NOTE</p> <ul style="list-style-type: none"> Run the True Color Finder program. Calibration settings for DVI / HDMI / DP(DisplayPort) will be saved separately. </div>

TROUBLESHOOTING

Check the following before calling for service.

No image appears	
Is the power cord of the display connected?	<ul style="list-style-type: none"> • Check and see if the power cord is connected properly to the power outlet.
Is the power indicator light on?	<ul style="list-style-type: none"> • Press the Power button.
Is the power indicator flickering?	<ul style="list-style-type: none"> • If the display is in sleep mode, try moving the mouse or pressing any key on the keyboard to bring up the screen. • Try to turn on the PC.
Do you see an "OUT OF RANGE" message on the screen?	<ul style="list-style-type: none"> • This message appears when the signal from the PC (video card) is out of horizontal or vertical frequency range of the display. See the 'Specifications' section of this manual and configure your display again.
Do you see a "NO SIGNAL" message on the screen?	<ul style="list-style-type: none"> • When the monitor is on "No-Signal" in 5 minutes, the monitor goes to DPM mode.

Can 't you control some functions in OSD?	
Can't you select some menu in OSD?	<ul style="list-style-type: none"> • You can unlock the OSD controls at any time by entering the OSD lock menu and changing items to off.

**CAUTION**

- Check **Control Panel ► Display ► Settings** and see if the frequency or the resolution were changed. If yes, readjust the video card to the recommend resolution.
- If the recommended resolution (optimal resolution) is not selected, letters may be blurred and the screen may be dimmed, truncated or biased. Make sure to select the recommend resolution.
- The setting method can differ by computer and O/S (Operation System), and resolution mentioned above may not be supported by the video card performance. In this case, please ask to the computer or the video card manufacturer.

Display image is incorrect

The screen color is mono or abnormal.	<ul style="list-style-type: none"> • Check if the signal cable is properly connected and use a screwdriver to fasten if necessary. • Make sure the video card is properly inserted in the slot. • Set the color setting higher than 24 bits (true color) at Control Panel ► Settings.
The screen blinks.	<ul style="list-style-type: none"> • Check if the screen is set to interlace mode and if yes, change it to the recommend resolution.

Do you see an "Unrecognized monitor, Plug&Play (VESA DDC) monitor found" message?

Have you installed the display driver?	<ul style="list-style-type: none"> • Be sure to install the display driver from the display driver CD (or diskette) that comes with your display. Or, you can also download the driver from our web site: http://www.lg.com. • Make sure to check if the video card supports Plug&Play function.
--	--

The screen is flickering.

Did you select the recommended resolution?	<ul style="list-style-type: none"> • If the selected resolution is HDMI 1080i 60/50 Hz, the screen may be flickering. Change the resolution to the recommended resolution 1080P.
--	---

SPECIFICATIONS

29UM67

LCD Screen	Type	73.025 cm TFT (Thin Film Transistor) LCD (Liquid Crystal Display) Screen Diagonal length of the screen: 73.025 cm
	Pixel Pitch	0.2628 mm x 0.2628 mm
Resolution	Maximum Resolution	2560 x 1080 @ 60 Hz
	Recommended Resolution	2560 x 1080 @ 60 Hz
Video Signal	Horizontal Frequency	30 kHz to 90 kHz
	Vertical Frequency	DP/HDMI :56 Hz to 75 Hz
	Synchronization	Separate Sync.
Input Connector	HDMI IN1, HDMI IN2 , DisplayPort, H/P	
Power	Voltage	19 V --- 2.4 A
	Power consumption (Typ.)	On mode: 31 W (ENERGY STAR® standard)* Sleep Mode ≤ 0.5 W Off Mode ≤ 0.5 W
AC/DC adaptor	Type DA-48F19, Asian Power Devices Inc. production Or type LCAP35, LIEN CHANG ELECTRONIC ENTERPRISE production Output: 19 V --- 2.53 A	
Environmental Conditions	Operating Condition	Temperature: 10°C to 35°C; Humidity: 10% to 80%
	Storing Condition	Temperature: -20°C to 60°C; Humidity: 5% to 90%
Stand Angle Adjustment	Forwards/Backwards: -5° to 20° (Head)	
Dimension	Monitor Size (Width x Height x Depth)	
	With Stand	70.3 cm x 41.8 cm x 18.1 cm
	Without Stand	70.3 cm x 32.8 cm x 6.4 cm
Weight (Without Packaging)	6.2 kg	

The specifications are subject to change without notice.

* The power consumption level can be different by operating condition and monitor setting.

* The On mode power consumption is measured with ENERGY STAR® test standard.

* ENERGY STAR® is a US registered mark of the United States Environmental Protection Agency.

SPECIFICATIONS

29UB67

LCD Screen	Type	73.025 cm TFT (Thin Film Transistor) LCD (Liquid Crystal Display) Screen Diagonal length of the screen: 73.025 cm
	Pixel Pitch	0.2628 mm x 0.2628 mm
Resolution	Maximum Resolution	2560 x 1080 @ 60 Hz
	Recommended Resolution	2560 x 1080 @ 60 Hz
Video Signal	Horizontal Frequency	30 kHz to 90 kHz
	Vertical Frequency	DVI: 56 Hz to 75 Hz HDMI: (AV)25 Hz to 60 Hz (PC)56 Hz to 75 Hz DP: 56 Hz to 75 Hz
	Synchronization	Separate Sync.
Input Connector	DVI-D IN, HDMI IN1, HDMI IN2, DP(DisplayPort) IN, H/P, USB	
Power consumption	On mode: 31 W (ENERGY STAR® standard)* Sleep Mode<1.2 W Off Mode < 0.3 W	
Power Input	AC 100-240V ~ 50/60Hz 1.5 A	
Environmental Conditions	Operating Condition	Temperature: 10°C to 35°C; Humidity: 10% to 80%
	Storing Condition	Temperature: -20°C to 60°C; Humidity: 5% to 90%
Stand Angle Adjustment	Forwards/Backwards: -5° to 35° (Head)	
Dimension	Monitor Size (Width x Height x Depth)	
	With Stand	70.3 cm x 40.4 cm x 25.2 cm
	Without Stand	70.3 cm x 32.1 cm x 6.4 cm
Weight (Without Packaging)	8.6 kg	

The specifications are subject to change without notice.

- * The power consumption level can be different by operating condition and monitor setting.
- * The On mode power consumption is measured with ENERGY STAR® test standard.
- * ENERGY STAR® is a US registered mark of the United States Environmental Protection Agency.

SPECIFICATIONS

34UM67

LCD Screen	Type	87 cm TFT (Thin Film Transistor) LCD (Liquid Crystal Display) Screen Diagonal length of the screen: 87 cm
	Pixel Pitch	0.312(H) mm x 0.310(V) mm
Resolution	Maximum Resolution	2560 x 1080 @ 60 Hz
	Recommended Resolution	2560 x 1080 @ 60 Hz
Video Signal	Horizontal Frequency	30 kHz to 90 kHz
	Vertical Frequency	DP/HDMI :56 Hz to 75 Hz
	Synchronization	Separate Sync.
Input Connector	DVI,HDMI IN1,HDMI IN2,DisplayPort,H/P	
Power	Voltage	19 V --- 3.3 A
	Power consumption (Typ.)	On mode: 43 W (ENERGY STAR® standard)* Sleep Mode ≤ 0.5 W Off Mode ≤ 0.5 W
AC/DC adaptor	Type DA-65G 19, Asian Power Devices Inc. production Or type LCAP39, LIEN CHANG ELECTRONIC ENTERPRISE production Output: 19 V --- 3.42 A	
Environmental Conditions	Operating Condition	Temperature: 10°C to 35°C; Humidity: 10% to 80%
	Storing Condition	Temperature: -20°C to 60°C; Humidity: 5% to 90%
Stand Angle Adjustment	Forwards/Backwards: -5° to 15° (Head)	
Dimension	Monitor Size (Width x Height x Depth)	
	With Stand	82.9 cm x 46.8 cm x 17.2 cm
	Without Stand	82.9 cm x 37.9 cm x 8.2 cm
Weight (Without Packaging)	7.3 kg	

The specifications are subject to change without notice.

* The power consumption level can be different by operating condition and monitor setting.

* The On mode power consumption is measured with ENERGY STAR® test standard.

* ENERGY STAR® is a US registered mark of the United States Environmental Protection Agency.

SPECIFICATIONS

34UB67

LCD Screen	Type	87 cm TFT (Thin Film Transistor) LCD (Liquid Crystal Display) Screen Diagonal length of the screen: 87 cm
	Pixel Pitch	0.312(H) mm x 0.310(V) mm
Resolution	Maximum Resolution	2560 x 1080 @ 60 Hz
	Recommended Resolution	2560 x 1080 @ 60 Hz
Video Signal	Horizontal Frequency	30 kHz to 90 kHz
	Vertical Frequency	DP/HDMI :56 Hz to 75 Hz
	Synchronization	Separate Sync.
Input Connector	DVI-D IN,HDMI IN1,HDMI IN2,DP(DisplayPort) IN,H/P,USB	
Power	Voltage	19 V --- 3.3 A
	Power consumption (Typ.)	On mode: 43 W (ENERGY STAR® standard)* Sleep Mode ≤ 1.2 W Off Mode ≤ 0.3 W
	AC/DC adaptor	Type DA-65G 19, Asian Power Devices Inc. production Or type LCAP39, LIEN CHANG ELECTRONIC ENTERPRISE production. Output: 19 V --- 3.42 A
Environmental Conditions	Operating Condition	Temperature: 10°C to 35°C; Humidity: 10% to 80%
	Storing Condition	Temperature: -20°C to 60°C; Humidity: 5% to 90%
Stand Angle Adjustment	Forwards/Backwards: -5° to 35° (Head)	
Dimension	Monitor Size (Width x Height x Depth)	
	With Stand	82.9 cm x 43.6 cm x 25.2 cm
	Without Stand	82.9 cm x 37.9 cm x 4.9 cm
Weight (Without Packaging)	8.6 kg	

The specifications are subject to change without notice.

- * The power consumption level can be different by operating condition and monitor setting.
- * The On mode power consumption is measured with ENERGY STAR® test standard.
- * ENERGY STAR® is a US registered mark of the United States Environmental Protection Agency.

Factory support mode (DVI-D/ HDMI/ DisplayPort)

Display Modes (Resolution)	Horizontal Frequency(kHz)	Vertical Frequency(Hz)	Polarity(H/V)	Remarks
720 x 400	31.468	70.08	-/+	
640 x 480	31.469	59.94	-/-	
640 x 480	37.5	75	-/-	
800 x 600	37.879	60.317	+/+	
800 x 600	46.875	75	+/+	
1024 x 768	48.363	60	-/-	
1024 x 768	60.123	75.029	+/+	
1152 x 864	67.5	75	+/+	
1280 x 720	45	60	+/+	
1280 x 1024	63.981	60.02	+/+	
1280 x 1024	79.976	75.025	+/+	
1600 x 900	60	60	+/+	
1680 x 1050	65.290	59.954	-/+	
1920 x 1080	67.5	60	+/-	
2560 x 1080	66.7	60	-/+	
1280 x 1080 (PBP only)	67.5	60	-/+	

HDMI Timing (Video)

Factory support mode (Preset Mode)	Horizontal Frequency(kHz)	Vertical Frequency(Hz)	Remarks
480P	31.50	60	
576P	31.25	50	
720P	37.50	50	
720P	45.00	60	
1080P	56.25	50	
1080P	67.50	60	

Indicator

Mode	LED Color
On Mode	White (Only 15 seconds)
Sleep Mode	Blinking White
Off Mode	Off

PROPER POSTURE

Proper Posture for Using the Monitor

Adjust the screen so that you can comfortably view at a slight downward angle from your natural eye level.

- Take a break for approximately ten minutes every hour to reduce any fatigue caused by long-time usage.
- The stand of the touch monitor allows the product to be used in the optimum position. Adjust the stand angle to obtain the best view of the screen.

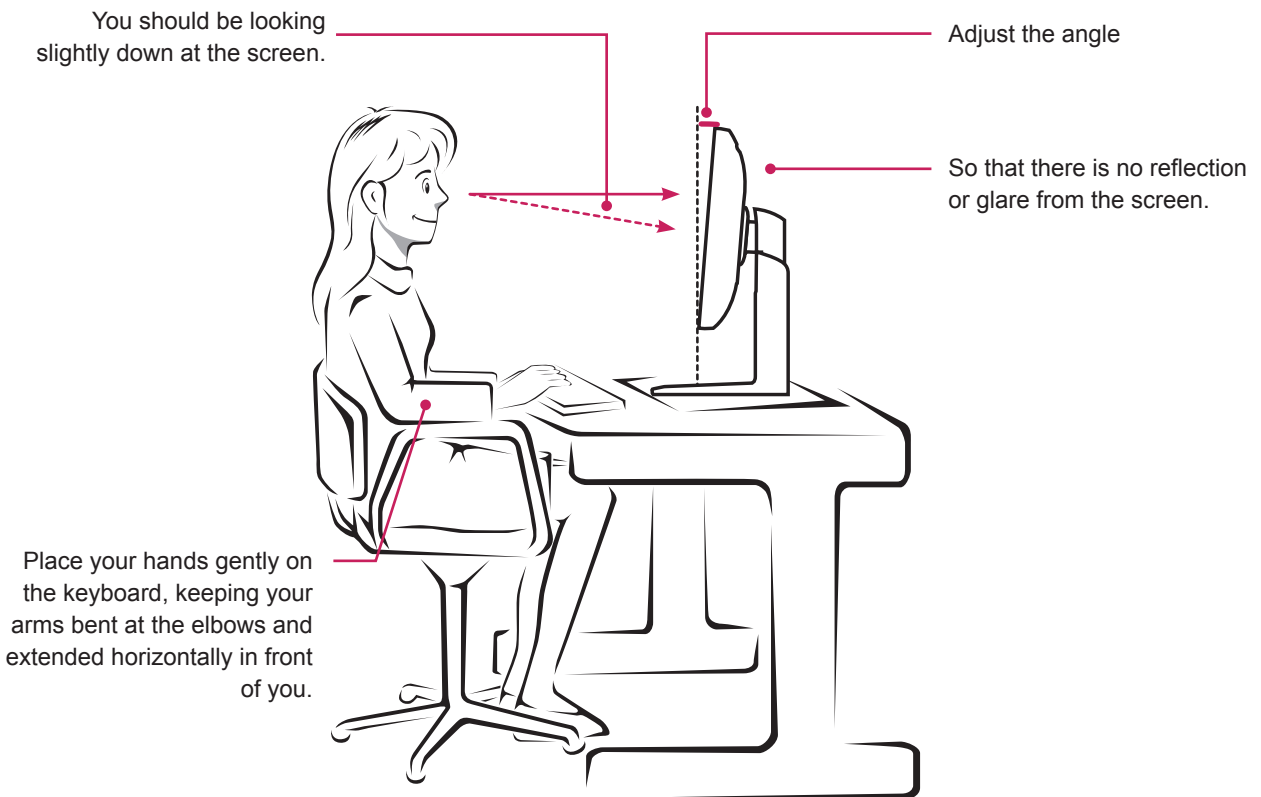



Declaration of Conformity

Trade Name: LG

Model : 29UM67, 29UB67, 34UM67, 34UB67

Responsible Party: LG Electronics Inc.

Address : 1000 Sylvan Ave. Englewood Cliffs
NJ 07632 U.S.A

TEL: 201-266-2534

*above information is only for USA FCC Regulatory

Make sure to read the Safety Precautions before using the product.

Keep the Owner's Manual (CD) in an accessible place for future reference.

The model and serial number of the SET is located on the back and one side of the SET. Record it below should you ever need service.

MODEL _____

SERIAL _____

ENERGY STAR is a set of power-saving guidelines issued by the U.S.Environmental Protection Agency(EPA).



As an ENERGY STAR Partner LGE U. S. A.,Inc. has determined that this product meets the ENERGY STAR guidelines for energy efficiency.

Refer to ENERGY STAR.gov for more information on the ENERGY STAR program.